



UNIVERSITÀ POLITECNICA DELLE MARCHE  
Repository ISTITUZIONALE

Broadband Microwave Attenuator Based on Few Layer Graphene Flakes

This is the peer reviewed version of the following article:

*Original*

Broadband Microwave Attenuator Based on Few Layer Graphene Flakes / Pierantoni, Luca; Mencarelli, Davide; Bozzi, Maurizio; Moro, Riccardo; Moscato, Stefano; Perregrini, Luca; Micciulla, Federico; Cataldo, Antonino; Bellucci, Stefano. - In: IEEE TRANSACTIONS ON MICROWAVE THEORY AND TECHNIQUES. - ISSN 0018-9480. - ELETTRONICO. - 63:8(2015), pp. 2491-2497. [10.1109/TMTT.2015.2441062]

*Availability:*

This version is available at: 11566/234306 since: 2022-06-15T12:22:11Z

*Publisher:*

*Published*

DOI:10.1109/TMTT.2015.2441062

*Terms of use:*

The terms and conditions for the reuse of this version of the manuscript are specified in the publishing policy. The use of copyrighted works requires the consent of the rights' holder (author or publisher). Works made available under a Creative Commons license or a Publisher's custom-made license can be used according to the terms and conditions contained therein. See editor's website for further information and terms and conditions.

This item was downloaded from IRIS Università Politecnica delle Marche (<https://iris.univpm.it>). When citing, please refer to the published version.

note finali coverage

(Article begins on next page)

# Broadband Microwave Attenuator Based on Few Layer Graphene Flakes

Luca Pierantoni, *Senior Member, IEEE*, Davide Mencarelli, Maurizio Bozzi, *Senior Member, IEEE*,  
Riccardo Moro, *Member, IEEE*, Stefano Moscato, *Student Member, IEEE*,  
Luca Perregri, *Senior Member, IEEE*, Federico Micciulla, Antonino Cataldo, Stefano Bellucci

**Abstract**—This paper presents the design and fabrication of a broadband microstrip attenuator, operating at 1-20 GHz, based on few layer graphene (FLG) flakes. The RF performance of the attenuator has been analyzed in depth. In particular, the use of graphene as a variable resistor is discussed and experimentally characterized at microwave frequencies. The structure of the graphene-based attenuator integrates a micrometric-layer of graphene flakes deposited on an air gap in a microstrip line. As highlighted in the experiments, the graphene film can range from being a discrete conductor to a highly resistive material, depending on the externally applied voltage. As experimental evidence, it is verified that the application of a proper voltage through two bias tees, changes the surface resistivity of graphene, and induces a significant change of insertion loss of the microstrip attenuator.

**Index Terms**—Graphene, microstrip lines, nanoelectronics, tunable microwave devices.

## I. INTRODUCTION

THE UNIQUE ELECTRONIC PROPERTIES of single layer graphene triggered a massive effort in theoretical and experimental characterization of this new material. Besides graphene, more and more attention, as witnessed by a huge number of publications [1-5], is paid to few layer graphene (FLG), a promising material for electronic applications. The possibility to open a band gap in FLG, namely bilayer graphene, by application of a perpendicular electric field, or by surface metal adsorption, enables the fabrication of effective graphene FET with current on/off ratio exceeding that of single layer graphene by one order of magnitude or more [1]. The physics of multilayer graphene includes the study of the sequence of graphene sheets that brings about the various 3D graphite crystals: for instance, bilayer graphene could be hexagonal simple or Bernal bilayer graphene [6]. FLG has sheet conductivity as low as about 10  $\Omega$ /square in case of high quality suspended films [4], but typical values are in the range of 100-1000  $\Omega$ /square.

This work was supported in part by the European Project “Carbon Based Smart Systems for Wireless Applications,” (NANO-RF, n. 318352), and by the EU FP7 projects PIRSES-2012-318617 FAEMCAR, FP7-PEOPLE-2013-IRSES-610875 NAmiceMC.

L. Pierantoni and D. Mencarelli are with Polytechnic University of Marche, Ancona, 60100, Italy, and with the National Institute of Nuclear Physics, Frascati, 00044, Italy (e-mail: l.pierantoni@univpm.it, d.mencarelli@univpm.it).

M. Bozzi, R. Moro, S. Moscato, L. Perregri are with University of Pavia, 27100, Italy (e-mail: maurizio.bozzi@unipv.it, riccardo.moro@unipv.it, stefano.moscato01@universitadipavia.it, luca.perregri@unipv.it).

A. Cataldo, F. Micciulla, and S. Bellucci are with the National Institute of Nuclear Physics, Frascati, 00044, Italy (e-mail: federico.micciulla@Inf.infn.it, antonino.cataldo@Inf.infn.it, stefano.bellucci@Inf.infn.it).

Owing to its outstanding properties, graphene is used in radio-frequency nanoelectronics [7-9] to realize novel high-speed devices such as field effect transistors [10], frequency multipliers [11], transparent solar cells [12], meta-materials [13], and graphene plasmonics [14]. Nevertheless, the possibility of using graphene in passively guided devices and antennas from microwaves to THz has been less explored [15]-[16]. This is mainly because such structures require electric sizes in the order of the electromagnetic wavelength, while the size of the first available graphene samples was much smaller. However, graphene chemical vapor deposition (CVD) currently allows obtaining samples of up to several centimeters, which has increased the research interest for realizing passive devices at such frequencies [17].

In previous works [18]-[21], the potential application of graphene for the implementation of tunable microstrip components has been investigated only theoretically. In particular, [18] reports the design of a graphene-based electronically tunable microstrip attenuator, operating at 5 GHz with approximately 1 GHz bandwidth.

In this paper, we experimentally demonstrate the use of FLG as a broadband tunable resistor at microwave frequencies. In particular, we present the design, fabrication, and testing of a graphene-based electronically tunable microstrip attenuator operating from 1 GHz up to 20 GHz. An innovative fabrication process of FLG is presented in Sec. II. The experimental verification of the tunable microstrip attenuator is reported in Sec. III. Some final remarks are reported in Sec. IV. This concept lays the groundwork for the development of tunable microwave and mm-wave passive components, likely to represent the fundamental building blocks for future transmitting/receiving (T/R) modules for nanoscale microwave communication systems.

## II. GRAPHENE FABRICATION: AN INNOVATIVE TECHNIQUE

Standard graphene fabrication methods include three techniques, i.e., exfoliation, epitaxial growth, and chemical vapour deposition (CVD) on metal. In the first method a scotch tape technique is employed. In the second one, silicon is thermally desorbed and the result is a sublimation of Si atoms from the surface of the SiC (in ultra-high vacuum). In the CVD on metal catalyst, typically Ni, Cu, Ru, Ir, TiC, TaC, are in use. The process occurs at temperatures 850-1000°C. Afterwards, the graphene gets transferred to desired substrates, by suitable techniques [22]. The CVD graphene fabrication method has a high potential for large areas (roll to roll production) [23]. It has the potential to enable monolayer vs. multilayer control (thanks to solubility features).

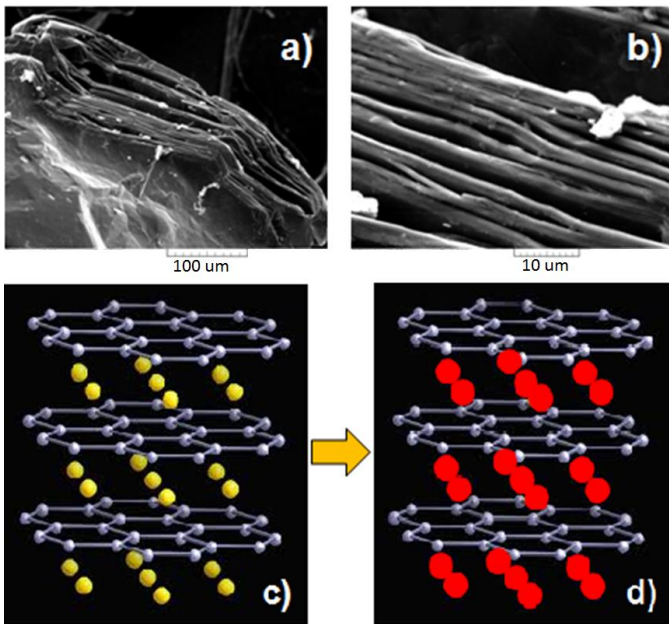

Fig. 1. Expandable graphite intercalated with chemical substances, before a), c) and after b), d) microwave irradiation-induced thermal expansion.

Moreover, it can yield samples of good quality (depending on grain boundaries, defects etc.). A variant of the CVD deposition technique, is described in [24], where the few-layer graphene was synthesized in the absence of any metallic catalyst by microwave plasma enhanced CVD with gas mixtures of methane and hydrogen.

The deposit consists of nanostructures that are several micrometers wide, highly crystalline stacks of four to six atomic layers of graphene, aligned vertically to the substrate surface. Then a comparative study of the electric field emission behavior of vertically aligned few-layer graphene and carbon nanotubes was evaluated in a parallel plate type setup in [25]. In the current design, the adopted graphene patch was obtained by means of an innovative technique introduced recently by the authors [26]. Expandable graphite produced and commercialized by Asbury is used as a source to obtain graphene nanoplatelets. This kind of expandable graphite is intercalated with chemical substances, normally sulfates and nitrates, inserted between the graphene planes of the graphite. As the material undergoes a sudden thermal shock, the intercalating substances vaporize: hence the gas exerts a pressure between neighboring planes, which then separates them, thus exfoliating the material. The fabrication method is a variant of the customary thermal expansion obtained in a more conventional oven: normally treatments of such a kind are carried out in ovens where the temperature is kept about 1000°C.

The procedure realized by the authors is based instead upon the use of a normal household microwave (MW) oven: the MW irradiation of the sample produces a sudden heating of the graphite and the vaporization of the intercalating substances, which, in turn, modify the air dielectric properties, causes a series of sparks that self-feed the process. During the latter, the temperature grows above 1000°C.

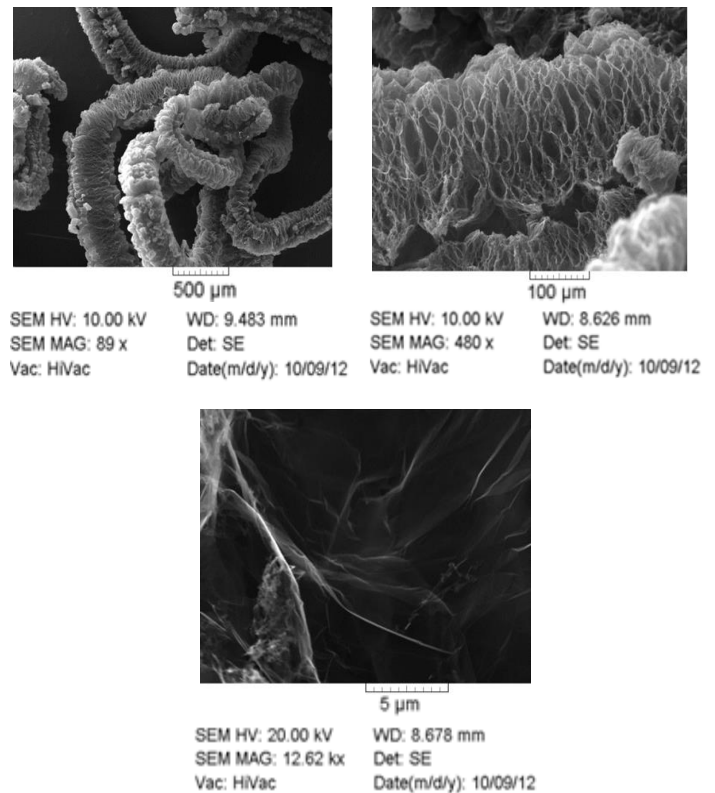

Fig. 2. Worm like structures obtained after the MW irradiation-induced thermal expansion of the intercalated graphite. The scanning electron microscope micrographs show the implications of the expansion process on the intercalated multilayer graphite.

The procedure based on MW irradiation yields several advantages, with respect to the customary heating in a conventional oven, namely it is cheaper and “green” (just about 10 sec of MW irradiation vs. the amount of energy needed in order to heat up the normal oven and maintain its temperature at a constantly high value), very fast, very safe, as the operator does not need introducing the intercalated, expandable graphite in a high temperature environment (e.g., as in a conventional oven), and eco-friendly (as it is solvent-free).

After the MW irradiation-induced thermal expansion, the samples appear to have the following morphological and structural characteristics (Fig. 1): worm like structure, very large particle area, thickness:  $6 \pm 3$  planes. To be specific, after the expansion of the intercalated graphite, the obtained

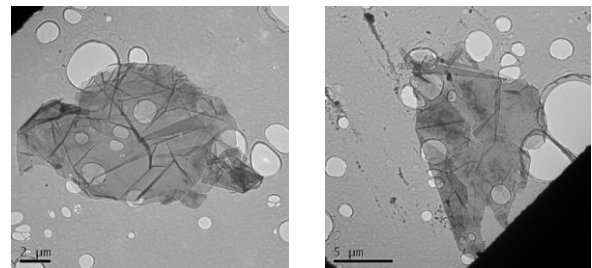

Fig. 3. Graphene nanoplatelets freed from the worm like overall structure. The images show particles with the two dimensional lateral sides having sizes about tens micrometers and a thickness less than 5 nm.

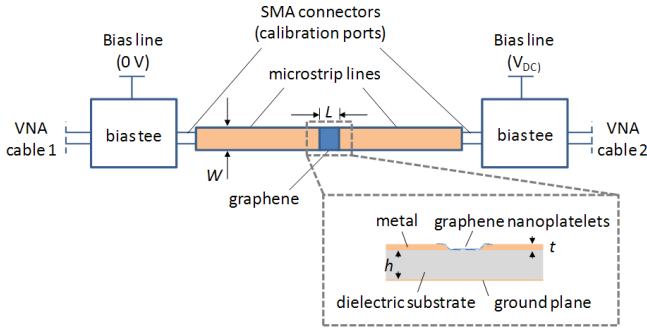

Fig. 4. Geometry of the measurement setup of the graphene-based microstrip attenuator.

samples, in the form of worm like structures, are seen in Fig. 2. The scanning electron microscope micrographs show how the intercalated multilayer graphite turns out to have undergone an expansion process. By means of a short treatment with ultrasound in isopropyl alcohol, the graphene nanoplatelets can be freed from the worm like overall structure, thus forming particles with the two dimensional lateral sides having sizes about tens micrometers and a thickness less than 5 nm (i.e., several layers), see Fig. 3.

### III. TUNABLE MICROSTRIP ATTENUATOR

#### A. Design of the Tunable Attenuator

The graphene-based microstrip attenuator consists of a microstrip line with a gap, where the FLG is located. The circuit is designed on a TSM-DS3 Taconic dielectric substrate with thickness  $h=254\ \mu\text{m}$ ,  $\epsilon_r=3.0$   $\tan\delta=0.0011$ , and metal thickness  $t=17\ \mu\text{m}$  (Fig. 4). To obtain 50- $\Omega$  microstrip lines, a width  $W=620\ \mu\text{m}$  was adopted. The length of the gap is  $L=500\ \mu\text{m}$ . The gap area is filled with graphene nanoplatelets (Fig. 3), with dimension in the order of 5-10  $\mu\text{m}$ .

The schematic of the experimental set-up is shown in Fig. 4: the structure consists of the microstrip line with a gap, where the FLG is located, and two bias tees to proper bias the graphene. The operation principle of the attenuator is based on the tuning of the graphene resistance, as discussed in [18]-[21]. Differently from previous works, the bias of the graphene is performed by using commercial bias tees, which allow for broadband operation.

The electromagnetic modeling of the structure is based on a commercial FEM solver, where the graphene is modeled as an infinitely thin resistive patch with assigned resistance  $\rho$ . Fig. 5a shows the simulated scattering parameters of the structure, for different values of  $\rho$  (20, 80, and 150  $\Omega/\text{square}$ ). The simulation results show the broadband performance of the structure. In addition, it is interesting to analyze the different contributions to the insertion loss, coming from reflection ( $|S_{11}|^2$ ) and dissipation ( $1-|S_{11}|^2-|S_{21}|^2$ ): for small values of graphene resistance, the major contribution to the insertion loss comes from dissipation, whereas for higher values of  $\rho$  the contribution of reflection and dissipation are comparable (Fig. 5b). Note that the same effect can be practically obtained by using a circuit with two 50- $\Omega$  microstrip lines connected to a series lumped resistor, with resistance  $R=\rho L/W$ .

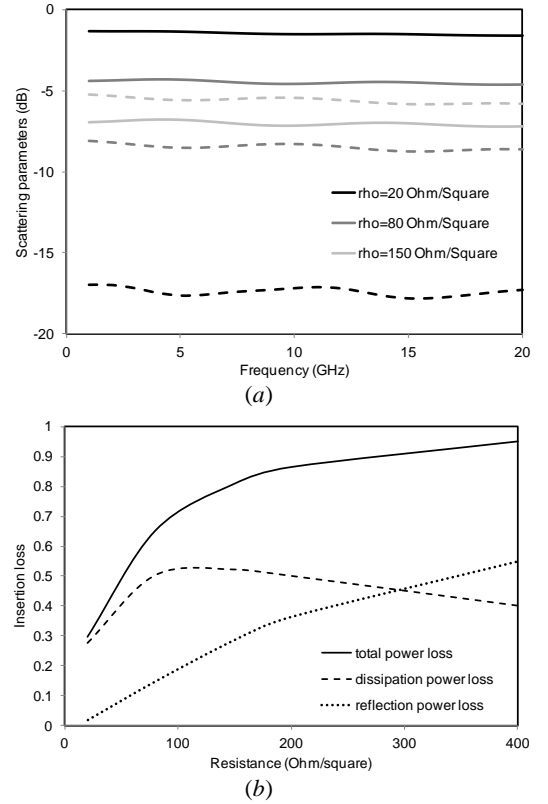

Fig. 5. Simulated frequency response of the microstrip attenuator: (a) scattering parameters, for different values of the surface resistance (solid lines refer to  $|S_{21}|$ , dashed lines refer to  $|S_{11}|$ ); (b) different components of insertion loss at the frequency of 10 GHz.

#### B. Experimental Validation

A prototype of the microstrip attenuator has been fabricated to verify the electromagnetic performance and tunability of the proposed structure. The manufacturing of the circuit has been performed by using a LPKF micro-milling machine. A 45° slope between the microstrip line and the gap has been introduced, to guarantee a better deposition of the graphene nanoplatelets (Fig. 6a).

DC and RF measurements have been performed by using the setup shown in Fig. 6b, which includes an Anritsu test fixture UTF 3680-20 and two bias tees SigaTek SB14D2. The measurements were performed with different values of DC voltage  $V_{DC}$  applied to the bias tees. For each value of DC voltage, DC current and insertion loss in the frequency band from 1 to 20 GHz were measured. For RF measurements, the calibration was performed at the SMA connectors of the test fixture, thus removing the effect of the bias tees (calibration ports in Fig. 6b).

Fig. 7 shows the value of DC current  $I_{DC}$  entering the bias tee and passing through the graphene patch versus DC bias voltage, and the resulting DC resistance  $R=V_{DC}/I_{DC}$ . The value of  $R$  for zero bias voltage was measured by using a multimeter. Current  $I_{DC}$  increases with increasing  $V_{DC}$ , which corresponds to decreasing resistance  $R$  (from approximately  $R=1.1\ \text{k}\Omega$  at  $V_{DC}=0$  to  $R=40\ \Omega$  at  $V_{DC}=5.5\ \text{V}$ ).

The measured insertion loss is shown in Fig. 8 for different values of DC bias voltage. Due to the position of the calibration ports, this insertion loss accounts for losses of the

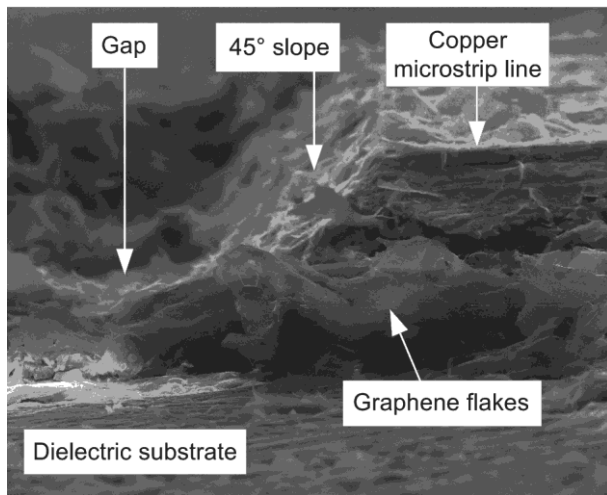

(a)

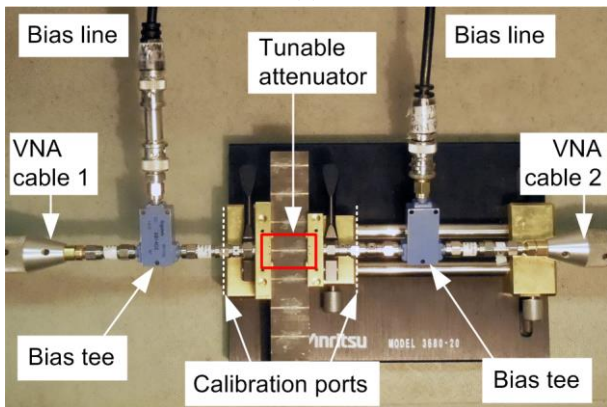

(b)

Fig. 6. Experimental verification of the graphene-based microstrip attenuator: (a) microscope photograph of the prototype, showing a microstrip line and the gap region; (b) photograph of the measurement setup.

microstrip lines and the graphene patch only. The tunability of the insertion loss is observed over the entire frequency range. In particular, a larger tuning range is achieved at lower frequency (5.5 dB at 1 GHz), while smaller values down to 2.5 dB are achieved at the frequency of 20 GHz.

The measured insertion loss at 10 GHz versus DC bias voltage is shown in Fig. 9a: the insertion loss does not change significantly for low values of DC voltage, and it rapidly decreases for  $V_{DC} > 2$  V. A tuning range of approximately 4.5 dB was measured. The insertion loss can be shown in a more effective way versus  $R = \rho L/W$ , in order to compare experimental results with simulations (Fig. 9b). Two major phenomena can be observed: the measurement results exhibit saturation for large values of resistance, and there is a shift between simulation and measurement results. The saturation effect is due to the (finite) maximum value of graphene resistance, which does not grow to infinity (Fig. 7). The shift is partially due to additional losses, but there is another possible explanation: the fabricated graphene patch is larger than the gap area, and consequently the value of  $R$  measured at DC results lower than the effective graphene resistance at RF frequency. Therefore, the measured curve of insertion loss is shifted towards lower values of resistance.

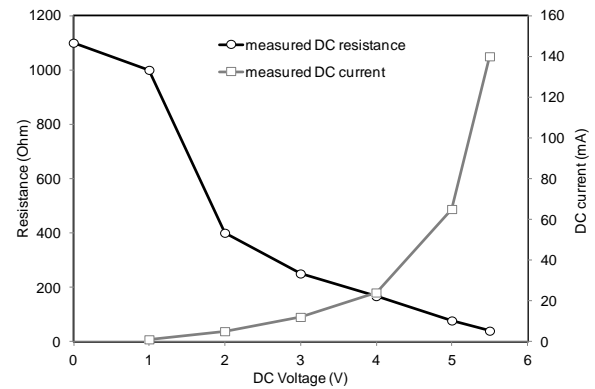

Fig. 7. Measured DC current and DC resistance of the graphene-based microstrip attenuator.

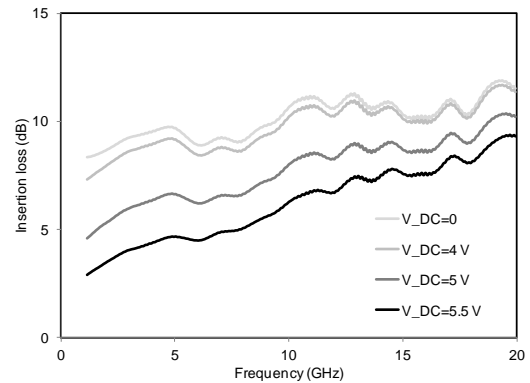

Fig. 8. RF measured insertion loss of the attenuator versus frequency, for different value of the bias voltage  $V_{DC}$ .

When setting a value of bias voltage of 6 V the circuit breaks. As observed in Fig. 7, the DC current grows significantly when increasing the DC bias voltage. For a bias voltage  $V_{DC} = 5.5$  V, the measured current is  $I_{DC} = 140$  mA, corresponding to a total DC power of 0.77 W dissipated by the graphene patch. Preliminary thermal measurements performed by using a thermo camera show a temperature increase up to 80°C. This value could be underestimated, as the camera makes an average of the graphene area and surroundings.

### C. Final Remarks

The proposed device is not directly comparable with commercial devices and microwave attenuators based on state-of-the-art technologies, e.g., solid-state attenuators, in terms of compactness and overall performance (accuracy, repeatability, achievable levels of resistance, attenuation, etc.). However, the main purpose of the present contribution is to demonstrate the possibility of using a novel material, based on stacked graphene, for microwave applications. To this aim, a complete characterization of the material, including breakdown features, has been carried out. Moreover, many technical and practical issues have been overcome, like correct deposition/positioning of graphene flakes and shaping of the microstrip gap. The achieved practical solution is very preliminary: nonetheless, it shows an appreciable attenuating effect, besides a wide operation bandwidth. Further improvements of the present configuration are on their way to design and fabrication, as the object of further work.

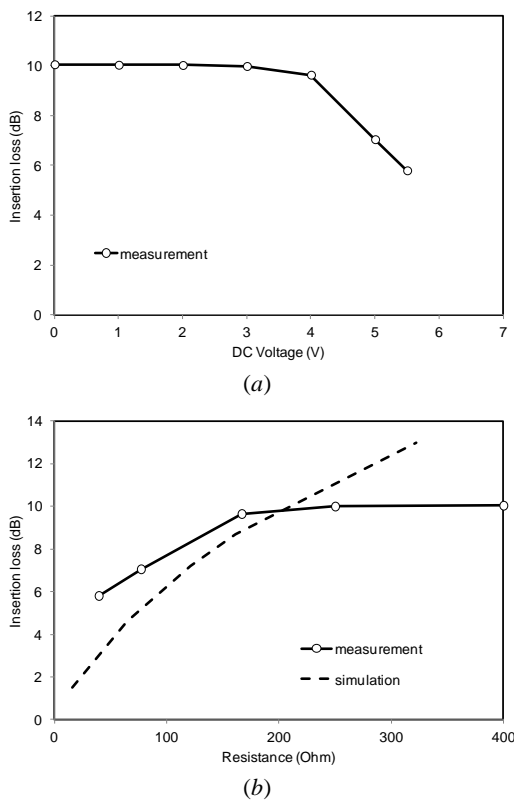

Fig. 9. RF measured performance of the graphene-based microstrip attenuator: (a) measured insertion loss at 10 GHz versus DC bias voltage; (b) simulated and measured insertion loss at 10 GHz versus graphene resistance.

#### IV. CONCLUSION

The use of graphene as a variable resistor has been discussed and experimentally demonstrated in this paper with the aim of implementing an electronically tunable microstrip attenuator. The attenuator consists of a microstrip line with a gap, filled with graphene nanoplatelets. The graphene patch was obtained by means of an innovative technique, based on thermal shock. Depending on the applied voltage (which in turn modifies the resistance of graphene), the proposed attenuator exhibits a measured tunability of the insertion loss up to 5.5 dB. The attenuator presents broadband performance, measured from 1 to 20 GHz. The concept discussed in this specific case can be easily extended to several classes of passive microwave and mm-wave components in microstrip, coplanar, and substrate integrated waveguide technology.

#### REFERENCES

- [1] R. Quhe, J. Ma, Z. Zeng, K. Tang, J. Zheng, Y. Wang, Z. Ni, L. Wang, Z. Gao, J. Shi, and J. Lu, "Tunable band gap in few-layer graphene by surface adsorption," *Scientific Reports* 3, 1794, 2013.
- [2] L.G. De Arco, Y. Zhang, A. Kumar, and Z. Chongwu, "Synthesis, transfer, and device of single and few-layer graphene by chemical deposition," *IEEE Transactions on Nanotechnology*, Vol. 8, No. 2, pp. 135–138, 2009.
- [3] A. Malesev, R. Kempf, A. Vanhulsel, M. P. Chowdhury, A. Volodin, and C. Van Haesendonck "Field emission from vertically aligned few-layer graphene," *Journal of Applied Physics*, Vol. 104, No. 8, pp. 084301-084305, Oct 2008.
- [4] N. Rouhi, Y.Y. Wang, and P. Burke, "Ultrahigh conductivity of large area suspended few layer graphene films," *J. Applied Physics Letters*, Vol. 101, No. 26, pp. 263101-263103, 2012.
- [5] T. Yu, C.-W. Liang, C. Kim, E.-S. Song, and B. Yu, "Three-Dimensional Stacked Multilayer Graphene Interconnects," *IEEE Electron Device Letters*, Vol. 32, No. 8, pp. 1110-1112, 2011.
- [6] Y. Hao, Y. Wang, L. Wang, Z. Ni, Z. Wang, R. Wang, C.K. Koo, Z. Shen, and J.T.L. Thong, "Probing Layer Number and Stacking Order of Few-Layer Graphene by Raman Spectroscopy," *Small*, Vol. 6, No. 2, pp. 195–200, 2010.
- [7] T. Monti, A. Di Donato, D. Mencarelli, G. Venanzoni, A. Morini, and M. Farina, "Near-field microwave investigation of electrical properties of graphene-ITO electrodes for LED applications," *IEEE/OSA Journal of Display Technology* Vol. 9, No. 6, pp. 504-510, 2013.
- [8] C.-Y. Sung, "Graphene nanoelectronics," *ISDRS International Semiconductor Device Research Symposium*, College Park, MD, 2009.
- [9] L. Pierantoni, F. Coccetti, and P. Russer, "Nano-electronics: The Paradigm Shift," *IEEE Microwave Magazine*, Vol. 11, No. 17, pp. 8-10, Dec. 2010.
- [10] Y. M. Lin, K. A. Jenkins, A. Valdes-Garcia, J. P. Small, D. B. Farmer, and P. Avouris, "Operation of graphene transistors at gigahertz frequencies," *Nano Lett.*, Vol. 9, No. 1, pp. 422-426, 2009.
- [11] H. Wang, D. Nezich, J. Kong, T. Palacios, "Graphene frequency multipliers," *IEEE Electr. Device Lett.*, Vol. 30, No. 5, pp. 547-549, 2009.
- [12] X. Wang, L. Zhi, and K. Mullen, "Transparent, Conductive graphene electrodes for dye-sensitized solar cells," *Nano Letters*, Vol. 8, No. 1, pp. 323-327, 2008.
- [13] A. Vakil, and N. Engheta, "Transformation optics using graphene," *Science*, Vol. 332, No. 6035, pp. 1291-1294, 2011.
- [14] M. Jablan, H. Buljan, and M. Soljacic, "Plasmonics in graphene infrared Frequencies," *Physical Review B*, Vol. 80, pp. 245435-1, 245435-7, 2009.
- [15] M. Dragoman, D. Neculoiu, A.-C. Bunea, G. Deligeorgis, M. Aldrigo, D. Vasilache, A. Dinescu, G. Kostantinidis, D. Mencarelli, L. Pierantoni, and M. Modreanu, "A tunable microwave slot antenna based on graphene," *Applied Physics Letters*, Vol. 106, No. 15, pp. 153101-1-153101-4, 13 April 2015.
- [16] D. Correas-Serrano, J. S. Gomez-Diaz, J. Perruisseau-Carrier, and A. Alvarez-Melcon, "Graphene-based plasmonic tunable low-pass filters in the terahertz band," *IEEE Transactions on Nanotechnology*, Vol. 13, No. 6, pp. 1145-1153, Nov. 2014.
- [17] A.N. Obraztsov *et al.*, "Chemical vapor deposition of thin graphite films of nanometer thickness," *Carbon.*, Vol. 45, No. 10, pp. 2017-2021, 2007.
- [18] L. Pierantoni, M. Bozzi, R. Moro, D. Mencarelli, and S. Bellucci, "On the Use of Electrostatically Doped Graphene: Analysis of Microwave Attenuators," *IEEE International Conference on Numerical Electromagnetic Modeling and Optimization (NEMO2014)*, Pavia, Italy, pp. 1-4, May 14-16, 2014.
- [19] L. Pierantoni, D. Mencarelli, M. Bozzi, R. Moro, and S. Bellucci, "Graphene-based Electronically Tunable Microstrip Attenuator," *2014 IEEE MTT-S International Microwave Symposium (IMS2014)*, Tampa Bay, Florida, pp. 1-3, June 1-6, 2014.
- [20] L. Pierantoni, D. Mencarelli, M. Bozzi, R. Moro, and S. Bellucci, "Microwave Applications of Graphene for Tunable Devices," *44th European Microwave Conference (EuMC2014)*, Roma, Italy, pp. 1456 – 1459, Oct. 6–9, 2014.
- [21] L. Pierantoni, D. Mencarelli, M. Bozzi, R. Moro, and S. Bellucci, "Graphene-Based Electronically Tunable Microstrip

- Attenuator,” *Nanomaterials and Nanotechnology*, Vol. 4, No. 18, pp. 1-6, June 2014.
- [22] H. Cao *et al*, “Electronic transport in chemical vapor deposited graphene synthesized on Cu: Quantum Hall effect and weak localization,” *Applied Physics Letters*, Vol. 96, 122106, 2010, <http://dx.doi.org/10.1063/1.3371684>.
- [23] S. Bae *et al*, “Roll-to-roll production of 30-inch graphene films for transparent electrodes,” *Nature Nanotech*, No. 5, pp. 574-578, June 2010.
- [24] S. Bellucci and A. Malesevic, “Physics of Carbon Nanostructures, in Physical Properties of Ceramic and Carbon Nanoscale Structures,” *Lecture Notes in Nanoscale Science and Technology II*, Springer Berlin Heidelberg, 2011, ISSN: 2195-2159.
- [25] S. Bellucci, A. Malesevic, F. Micciulla, I. Sacco, R. Kemps, A. Vanhulsel, and C. Van Haesendonck, “Comparative Field Emission from Vertically Aligned Few-Layer Graphene and Carbon Nanotubes,” *Nanoscience and Nanotechnology Letters*, Vol. 3, pp. 907-912, 2011.
- [26] A. Dabrowska, S. Bellucci, A. Cataldo, F. Micciulla, and A. Huczko, “Nanocomposites of epoxy resin with graphene nanoplates and exfoliated graphite: Synthesis and electrical properties,” Vol. 251, No. 12, pp. 2599–2602, Dec. 2014.