



UNIVERSITÀ POLITECNICA DELLE MARCHE  
Repository ISTITUZIONALE

CAD-integrated design for manufacturing and assembly in mechanical design

This is the peer reviewed version of the following article:

*Original*

CAD-integrated design for manufacturing and assembly in mechanical design / Campi, F.; Favi, C.; Germani, M.; Mandolini, M.. - In: INTERNATIONAL JOURNAL OF COMPUTER INTEGRATED MANUFACTURING. - ISSN 0951-192X. - 35:3(2022), pp. 282-325. [10.1080/0951192X.2021.1992659]

*Availability:*

This version is available at: 11566/294345 since: 2024-10-03T11:50:50Z

*Publisher:*

*Published*

DOI:10.1080/0951192X.2021.1992659

*Terms of use:*

The terms and conditions for the reuse of this version of the manuscript are specified in the publishing policy. The use of copyrighted works requires the consent of the rights' holder (author or publisher). Works made available under a Creative Commons license or a Publisher's custom-made license can be used according to the terms and conditions contained therein. See editor's website for further information and terms and conditions.

This item was downloaded from IRIS Università Politecnica delle Marche (<https://iris.univpm.it>). When citing, please refer to the published version.

(Article begins on next page)

# **CAD-integrated Design for Manufacturing and Assembly in mechanical design**

Federico Campi<sup>a\*</sup>, Claudio Favi<sup>b</sup>, Michele Germani<sup>a</sup>, Marco Mandolini<sup>a</sup>

<sup>a</sup>Università Politecnica delle Marche – via brecce bianche n. 12, 60121, Ancona, Italy

<sup>b</sup>Università degli Studi di Parma – Parco area delle scienze 181/A, 43121, Parma, Italy

\*f.campi@univpm.it

## **Abstract:**

Design for Manufacturing and Assembly (DfMA) is a consolidated engineering activity that suffers a real integration with 3D CAD systems. DfMA principles are currently applied downstream of the 3D modelling, by following the well-known rules available from the literature and company's know-how.

The paper provides a method to acquire, elaborate and represent DfMA rules sets to aid designers and engineers in developing mechanical products. This research work wants to define a general method able to couple DfMA design guidelines (knowledge-based design) with geometrical product features available by the investigation of the 3D model. The analysis of the 3D CAD model allows to anticipate manufacturing issues and to control manufacturing cost during product design. Moreover, a framework to embed this approach within a 3D CAD system is presented for future development in a software tool.

Two case studies, a simple casing made of six parts and a centrifugal pump made of sixty-eight parts, highlight how the proposed method allows easy deployment of this approach in DfMA projects. Several benefits are recognized: (i) anticipation of manufacturing and assembly issues, (ii) reduction of manufacturing and assembly cost and, (iii) reduction of effort and time required by designers during the product development process.

## **Keywords:**

DFMA, Design for Manufacturing and assembly, Knowledge-based design, CAD, Design guidelines, Feature recognition.

## **Word count:**

With references: 11646

Without references: 9930

# 1. Introduction

Product Development Process (PDP) is a consolidated engineering activity that takes a service or a product from conception to market. Product development includes few steps: drafting the concept, creating the overall design, developing a detailed design, and prototyping. While the first stages of the PDP consist of iterative steps able to figure out conceptual solutions (idea generation), the last stages of the PDP are characterized by more practical activities with recursive tasks (engineering design). The engineering design defines the complete specification of the geometry, materials, and tolerances of all the product's parts by defining detailed drawings (part drawing), and general assembly drawings. The result of this phase is the complete and precise physical description of all the product's parts. These drawings are issued with manufacturing purposes for actual manufacture and assembly. One of the most recurring disciplines in the engineering design contexts relates to solid modelling and drawing. Since its birth, CAD (Computer-Aided Design) evolved from an electronic drawing board to a 3D solid modeller with parametric philosophy. Nowadays, CAD tools combine the initial capabilities for which they were conceived (e.g., to virtually create the part, display it in a 3D view environment, verify the consistency of the final assembly and quickly realize 2D engineering drawing) with the benefits deriving from the integration of the multidisciplinary design methodologies. During the time, CAD systems integrated different disciplines for specific aims, such as environmental assessment (Morbidoni, Favi, and Germani 2011), ergonomic assessment (Marconi et al. 2018), etc.

Conversely, Design for Manufacturing (DfM) and Design for Assembly (DfA), which are consolidated engineering activities, suffered a real integration with 3D CAD systems. DfM and DfA principles are currently applied downstream of the 3D modelling, by following the well-known DfM and DfA guidelines available from the literature and company's know-how (tacit internal knowledge) whose dissemination among employees and technical departments is a critical issue. The mentioned practice highlights a gap in the state-of-art related to the CAD-integrated DfM and DfA methods and tools and the possibility to share manufacturing and assembly knowledge in the product design (explicit knowledge). Iterations required by the project revision due to manufacturing and assembly issues have tremendous impacts on the amount of time and rework. The integration of DfM and DfA within computer-aided design software can reduce redesign and control activities and, finally, the overall project cost.

Following the research gap illustrated above, three research questions are still unresolved:

1. How to make explicit the heterogeneous manufacturing and assembly knowledge to assist product designers during the design process and the 3D solid modelling?
2. What is the set of information available from the investigation of the 3D CAD model (i.e., type of feature to recognize, parameter to query) necessary to develop a CAD-integrated DfM/DfA system and tool?
3. What is the link between DfM/DfA rules and the product's cost, and how to estimate the cost savings of the design changes during the 3D modelling?

The goal of the paper is to address these questions, providing a method that helps designers during the 3D modelling activities oriented to manufacturing and assembly. In particular, this research work aims to close the gap between the design departments and production by creating a knowledge-based (KB) system able to translate tacit knowledge about DfM/DfA into explicit and reusable knowledge. The KB system is used to verify manufacturing and assembly concerns early in the design process (embodiment design) by analysing the 3D product features, give feedback about the design choices implemented in a given model, and estimate manufacturing and assembly Key Performance Indicators (KPIs). The analysis of a 3D CAD model allows to anticipate manufacturing issues and control manufacturing cost during product

design. This work encompasses several engineering design topics such as knowledge-based engineering, CAD modelling and feature recognition, design methodology, manufacturing technology, and cost estimation.

The novel contribution of this work consists in the definition of a methodological framework that can be adopted for the development of a CAD-integrated DfM/DfA tool. This novelty deals with the current limitation observed by analysing the industrial and scientific state-of-art. The presented methodology provides the basis for linking 3D modelling (geometric features) with engineering practices oriented to manufacturing and assembly during the product development process. The definition of a methodological framework is considered the starting point for developing a software tool to embed within a 3D CAD system. However, the CAD-integrated Design for Manufacturing and Assembly software tool development is beyond the scope of this work.

The paper is structured as follow: after this introduction, section 2 presents the literature analysis of related works about the same topic. Section 3 describes the overall methodology, including the DfM/DfA data collection, knowledge formalization and link with geometric features retrieved by the analysis of the CAD model. Section 4 investigates the applicability of the CAD-integrated DfM system to given technologies: the machining processes (DfM) and the manual assembly (DfA) of two case studies. Section 5 discusses the results obtained in both case studies highlighting the applicability of the methodology also for complex mechanical products. Section 6 reports concluding remarks and future perspectives on this subject.

## **2. Literature review**

The analysis of the literature refers to the three research questions reported in the introduction.

The first topic concerns “*engineering design for manufacturing and assembly*”. The following keywords were analysed: (i) DfM and DfA (rules and guidelines), (ii) manufacturing knowledge-based design and representation (ontology), and (iii) knowledge computation (explicit knowledge).

The second topic concerns “*CAD-integrated DfM and DfA systems and tools*”. The following keywords were analysed: (i) 3D CAD features detection and extraction (feature recognition), and (ii) feature properties and parameters (data reading).

The third topic concerns “*3D cost estimation analysis*”. The following keywords were analysed: (i) product cost analysis (cost estimation), (ii) 3D analytical cost models, and (iii) 3D future-based cost models.

A synthesis and novel aspects of the proposed method are reported at the end of the literature review.

### **2.1. Engineering design for manufacturing and assembly**

PDP is a long and iterative process for specific products. During the PDP, five main design activities are identified before the product release to the market: (i) problem definition and customer requirements, (ii) conceptual design, (iii) embodiment design, (iv) detailed design, and (v) prototyping. (Pahl et al. 2007; Ulrich and Eppinger 2011). CAD tools are recognized as reliable and efficient in developing complex products during the early stages of product design (i.e., embodiment design and detail design). CAD tools allow designers to take advantage of the 3D product representation, switching from sketches to virtual models. Manufacturing/assembly issues are addressed during the initial design stage because decisions made at this point tend to affect the selection of materials, machine tools, and human resources that

must be used in the production process (Selvaraj, Radhakrishnan, and Adithan 2009; Nitesh-Prakash, Sridhar, and Annamalai 2014). Design for Assembly (DfA) is a systematic procedure aiming at the reduction of assembly time through the following actions: (i) reduction of the overall number of components in a given assembly, and (ii) elimination of critical assembly tasks (Boothroyd, Dewhurst, and Knight 2010). DfM is an engineering practice aiming at the simplification of the manufacturing process for cost reduction of a given component through the following actions: (i) selection of raw material type, (ii) selection of raw material geometry, (iii) definition of dimensional and geometrical tolerances, (iv) definition of roughness, (v) characterization of specific shape constraints based on the manufacturing process, and (vi) selection of secondary processing such as finishing (O'Driscoll 2002).

Preliminary attempts related to the manufacturing knowledge-based design and representation were made, providing the necessary background for the definition of the proposed work. Most of these works tried to formalize engineering knowledge about DfM using dedicated approaches aiming to describe mathematical models to link geometry and features of a virtual CAD model with well-known guidelines for product manufacturability. Concerning the formalization of manufacturing rules and guidelines through the adoption of a knowledge-based engineering system, many works are available within the engineering literature and spread in technical departments of a manufacturing company (Bralla 1999; Boothroyd, Dewhurst, and Knight 2010; El Wakil 2019). These handbooks are a collection of design rules related to the leading manufacturing technologies with a complete review of the essential features involved in the product manufacturability considering a given technology. Several authors tried to describe the relationship between projects (design parameters that achieve product functionalities) and manufacturing information (relevant DfM rules) by using different approaches such as axiomatic design theory (Ferrer et al. 2010), or a dedicated system (i.e. “manufacturing feature”) (Hoque et al. 2013). On the same aim, literature provides several attempts regarding DfM and DfA knowledge formalization using ontologies (Yang, Dong, and Miao 2008; Debord et al. 2018; Chhim, Chinnam, and Sadawi 2019). Within the design context, the need to create a conceptual framework for data exchange is amplified by the nature of design information, ranging from geometric descriptions of the part to manufacturing information such as materials, associated processes, and cost. Ontologies overcome this limitation since their focus is not only on data or knowledge but on the information context that lets specific access to detailed information parts to a later phase. DfM knowledge formalization was primarily debated in the literature and the collection of manufacturing issues to improve product design is a well-addressed topic. However, the link with product analysis for geometric features modification is still a grey area with potential research activities.

## **2.2. CAD-integrated DfM and DfA systems and tools**

Concerning the development of CAD-integrated DfM and DfA systems and tools, the literature is broader but dated. First attempts explored the application of feature-based representation to incorporate the tooling and process considerations into the early design stages (Chen et al., 1998). Parts created by a CAD system are represented by features, and the consequential impact on manufacture and assembly is evaluated by the knowledge-based design critique system. The developed tools allow the analysis of CAD models, integrating DfM principles which contribute to manufacturing time and rework reduction. However, all the available systems seem far to be implemented in a real software application, and several limitations were observed (i.e., missing key performance indicators to address the potential of design changes).

If the analysis of literature from the academic perspectives shows a gap in the design methodologies and tools able to implement DfM/DfA rules during the product modelling, the analysis of commercial solutions on this aim provides few exciting systems. DFMPRO® is a commercially available tool developed for mechanical and mechatronic industries. It

concerns the analysis of mechanical components in terms of manufacturability (DFMPRO 2021). With the same aim, but focusing on both manufacturing and assembly, DFMA from BOOTHROYD DEWHURST, Inc. is another solution to minimize the number of parts in a complex assembly (DFMA 2021). New features were added in the last releases, such as the CAD calculator of the software allows users to use cost driver information directly from a 3D model.

In all the mentioned systems and tools, feature extraction from a 3D solid model is a fundamental task in integrating DfX rules within the design process due to the possibility of checking design constraints when design changes are made. However, the literature analysis shows how CAD features recognition was mainly used after the design phase for downstream applications (i.e., reverse engineering, product inspection) (Wang et al. 2012). It is worth noting that reverse engineering is an interesting topic for feature extraction, but it may be time-consuming if designers need to work and manage the file formats (i.e., passing from a cloud points to mesh to B-rep representation). Besides, for the most consolidated manufacturing technology, the 3D model (B-rep representation) information is easy to extract for a manufacturing and assembly analysis. Referring to the extraction of relevant features from a CAD model (B-rep representation), some researches focused on the manufacturing process planning (CAD-CAPP integration) (Nasr and Kamrani 2006; Sunil and Pande 2010; Ma et al. 2018), including the recognition of solid features for automatic development of machine tool programs (CNC) (Gao, Zheng, and Gindy 2004; Hayasi and Asiabanpour 2009) or the freeform surface model recognition for metal forming operations (Holland et al. 2002; Zhang et al. 2004; Sunil and Pande, 2008). Although this topic was primarily debated for downstream applications (i.e., CAD-CAPP integration, reverse engineering, visual inspection, tolerance control and so on), the feature extraction and parameter data reading from a 3D CAD model for the DfM/DfA rules analysis in the early phase of the design process is still an open issue. Only preliminary works investigated the possibility of coupling CAD tools with DfM and DfA systems for an initial assessment of virtual models before the production stage.

### **2.3. 3D cost estimation analysis**

One of the most important indicators used to assess manufacturing and assembly performances is the cost (Thompson, Jespersen, and Kjærsgaard 2018). Cost is considered the main driver to optimize for achieving project success, and cost analysis is one of the oldest engineering practices. Design is the most impactful phase of the overall product life cycle. Decisions taken in the early design phase can drastically affect the overall cost of the project, including manufacturing and assembly (Boothroyd, Dewhurst, and Knight 2010). Cost estimation is an engineering tool able to drive design choices. Among the several methods developed for the cost analysis in the early engineering phase, two leading families can be identified: (i) qualitative methods, which are primarily based on comparative analysis of a new product and an existing one and, (ii) quantitative methods, which are based on a detailed analysis of product design, including its features and corresponding manufacturing processes (Niazi et al. 2005). Quantitative cost estimation methods include analytical methods, which are based on primary tasks decomposition, feature-based methods, which use geometric features as the basis for cost estimation, and parametric methods, founded on the relations between product characteristics and their cost (Chougule and Ravi 2006). Quantitative cost estimation methods are primarily used in the late stage of product design (embodiment design and detail design), targeting the manufacturing domain to achieve an accurate cost estimation and increase the level of granularity present in their models (Campi et al. 2020). Quantitative methods are robust and accurate because assessment uses a product decomposition structure collecting cost factors associated with production processes and morphological component features (Mandolini et al., 2020). These methods are used as a base analysis of Design to Cost (DtC) methods which focus on the cost reduction in the early phases of the PDP. Thus, DfM and DfA, together with

Design to Cost (DtC), are usually identified as the significant challenge for competitive design, where manufacturing and assembly information is translated into cost indices, effectively normalizing different information and making direct comparisons possible (Favi, Germani, and Mandolini 2016, 2018). As for manufacturing and assembly, other knowledge-based frameworks for cost estimation were developed in the scientific literature. One of the most relevant in mechanical design was proposed by Mandolini et al. (2020), including the possibility of analytically estimating the manufacturing cost of different components manufactured with traditional technologies (i.e., forging). The framework consists of: (i) a manufacturing process data structure and cost breakdown data structure which represents the logical sequence of the whole manufacturing process for transforming raw material into the final product, (ii) the model (cost routing) used for collecting the manufacturing-related knowledge, and (iii) the model (cost model) used for managing the cost-related knowledge considering each operation within a manufacturing process, and starting from a component's 3D virtual prototype. This work can be viewed as the starting point to develop an accurate analysis of the cost of design choices performed during the 3D CAD modelling, which can catch the cost improvement related to a feature modification. Another interesting approach proposed by Letaief, Tlija, and Louhichi (2020) uses feature data from a digital mock-up to detect the similarity between new and old products. In this case, a correspondence between features, followed by an update of the manufacturing data according to the new geometry, is established to assess the cost of the new CAD model. Again, commercial solutions are available for this aim. Cost estimation tools such as LeanCost from Hyperlean (LeanCOST 2021), Design-to-Cost from APriori (APriori 2021), and DFM: Concurrent Costing from BOOTHROYD DEWHURST, Inc. (DFMA 2021) are using CAD models as input to assess the manufacturing cost of a given component. The main differences characterizing each tool are related to the algorithm used for cost estimation and the logic used for the assessment (analytic vs. parametric models, etc.).

#### **2.4. Synthesis**

Despite the long history of DfA and DfM in engineering, these methodologies suffer from real integration and interoperability with design tools such as the CAD system. Indeed, these methodologies follow geometric modelling (downstream application), and design reviews are required to implement design solutions focused on manufacturing and assembly. Knowledge formalization related to manufacturing and assembly is a well-known topic in product design. It is considered the ground to develop effective and robust DfA/DfM methods and tools. However, the link with product analysis for geometric features modification is still a grey area with a potential for research activities. This is the first gap to cover in developing a CAD-integrated Design for Manufacturing and Assembly method and tool. On this aim, the approach proposed in this work uses a knowledge-based system to formalize tacit implicit knowledge, linking DfM/DfA rules defined for a given technology and material with CAD features and parameters. The use of ontology allows creating a broad database that collects DfM/DfA rules and guidelines, providing new blood to the academic research in this field.

On the other hand, commercial systems are available in the context of DfA/DfM. For example, DFMA from BOOTHROYD DEWHURST, Inc. focuses on minimizing parts in a complex assembly. At the same time, DFMPro® highlights critical features in terms of manufacturability. Both software are interesting solutions to fulfill DfA/DfM theory. However, they are not decision-making tools able to quantify the benefit of design changes. Therefore, other systems are necessary to estimate these changes (i.e., LeanCost from Hyperlean or Design-to-Cost from APriori). On this aim, the proposed methodology allows the integration of DfA/DfM with cost estimation to provide an effective tool for the decision-making process in the development of mechanical products. In addition, the tool is theoretically applicable to each technology without limitations to some specific manufacturing processes. This contribution deals with applied



research for industry, providing effective tools for the decision-making process of designers and engineers during their daily activities.

### 3. Materials and Method

The main idea underpinning this research study concerns the possibility to link DfM/DfA design rules with 3D CAD features developed during the engineering design process of parts or assemblies.

Intending to integrate DfM/DfA approach within the 3D CAD modelling, this section describes the materials and method used for this purpose. The CAD-integrated design for manufacturing and assembly method concerns the following aspects: (i) the process workflow (section 3.1), (ii) the methodological framework (section 3.2), (iii) the knowledge-based (KB) system (section 3.3), (iv) the method for CAD feature recognition (section 3.4), and (v) the KPIs used to address DfM/DfA issues (section 3.5).

#### 3.1 Process workflow

The process workflow of the proposed methodology is depicted in Figure 1. The picture includes the steps and the systems/tools of the framework used for implementing the workflow.

[INSERT FIGURE 1 HERE]

The five steps of the process workflow are explained below. It is worth noting that additional implementation details are provided in the section dedicated to the methodological framework (section 3.2).

**3D model data reading** – This step allows reading the necessary information from the 3D CAD model, used to characterize product features that are not compliant with the DfM/DfA rules. Within this step, a feature recognition system extracts the 3D product features and all the necessary information (parameters) for verifying their compliance with the DfM/DfA rules. For each product feature, data reading of the 3D CAD model requires the acquisition of information, such as feature type (e.g., slot, hole, pad), feature dimensions (e.g., length, diameter), PMI – Product Manufacturing Information (e.g., tolerance, roughness), etc. Four classes are defined based on the feature type (as explained in section 3.4): (i) component feature, (ii) geometric feature, (iii) interaction feature, and (iv) assembly feature. In particular, the first three refer to the manufacturing analysis of a component (DfM), while the latter refers to the assembly analysis of a product (DfA). Systems/tools of the methodological framework used within this step refer to the 3D CAD tool and CAD feature system recognition.

**DfM/DfA rules analysis** – This step allows checking all the design rules stored in the DfM/DfA rules DB with the features retrieved by studying the 3D model (previous step). Adopting a KB system allows switching from tacit (implicit) knowledge (the one that lies in company employers or written within the engineering handbooks) to explicit knowledge. The KB system (explained in detail in section 3.3) enables the definition of declarative rules by invoking the concepts of the design (DfM/DfA, features, parameters) and manufacturing (technology and material) ontologies and inferring knowledge of design recommendations. Thus, a dedicated repository (DfM/DfA rules DB) is used to collect all the

information (DfM/DfA rules) in a structured manner (explicit knowledge). The KB system informs the designer about the validated and non-validated DfM/DfA rules highlighting within the 3D CAD model the features that provide non-validated DfM/DfA rules. These features require to be modified since they are not compliant with manufacturing and assembly operations. The designer uses the feedback to modify the non-compliant features of the 3D CAD model according to the design guidelines. If the analysis of the 3D model, which includes the investigation of all the 3D model features, is compliant with the explicit knowledge (all the model features satisfy the rule), the rule is validated (Boolean output, TRUE). On the other hand, if the analysis of the 3D model is not compliant with the explicit knowledge (exist at least one feature that does not satisfy the rule), the rule is non-validated (Boolean output, FALSE). In this manner, designers are informed about those features that are not compliant with the guidelines collected in the repository. Systems/tools of the methodological framework used within this step refer to the KB system, which embeds the DfM/DfA rules DB.

**DfM/DfA KPIs calculation** – This step calculates the KPIs related to the product manufacturing and assembly. Both KPIs are related to the cost (i.e., manufacturing cost and assembly cost), but they are assessed using different approaches. In manufacturing, the analytic cost estimation process is used to determine the cost associated with a design feature (Germani, Cicconi, and Mandolini 2011; Mandolini et al. 2020). The model developed for the numerical assessment was developed in a previous work of the same authors, and it falls outside the objective of this paper. In the case of assembly, authors adopted the approach proposed by Boothroyd and Dewhurst, where each item involved in an assembly task has a cost (Boothroyd, Dewhurst, and Knight 2010). Again, the model developed for the numerical assessment was developed in previous work, and it falls outside the objective of this paper. Both models used for the cost assessment are briefly described in section 3.5. It is worth noting that even if the models used for cost assessment were derived from the state-of-art, the application as a decision-making tool in the development of cost-effective DfM/DfA solutions is a novel contribution in this field. Systems/tools of the methodological framework used within this step refer to the DfM/DfA environment.

**DfM/DfA report generation** – This step allows generating two different reports: (i) a component report, including the type of manufacturing operation associated with each feature, and the related performance (i.e., cost of a manufacturing operation), and (ii) a product report, including the type of assembly operations and the corresponding performance (i.e., cost of assembly operation). Following the outcomes stated in the reports, the designer can adjust the 3D model following the suggestions included within the non-validated design guidelines. Systems/tools of the methodological framework used within this step refer to the DfM/DfA environment.

**3D model update** – This step allows modifying the 3D model by following the non-validated design guidelines included within the reports. Each design guideline describes, in addition to the type of design action to implement, the reason why each one improves the part manufacturability or the assembly task. Moreover, a picture shows how to implement a rule. Through the feature recognition system, those specific features related to non-validated rules can be highlighted within the 3D model to facilitate design modifications. Systems/tools of the methodological framework used within this step refer to the 3D CAD tool.

Once the designer implemented the modifications, a new analysis is run to verify whether the updated 3D model fits with the DfM/DfA requirements. If non-validated rules are still present and the KPIs are not compliant with the project target, a new design review is required. On the other hand, if there are no non-validated rules and the KPIs meet the project requirements, the model is ready to be finalized for manufacturing.

### 3.2 Methodological framework

The overall framework consists of four interlinked modules: (i) the DfM/DfA environment with the graphic user interface (GUI), (ii) the KB system, which includes the DfM/DfA rules DB, (iii) the CAD feature recognition system, and (iv) the CAD software tool. Figure 2 presents the CAD-integrated design for manufacturing and assembly framework.

[INSERT FIGURE 2 HERE]

The CAD tool is the software environment used in the embodiment phase of engineering design. Several CAD tools are commercially available, but the proposed approach is independent of the type of system used for 3D modelling. For this reason, the CAD software tool is not deeply analyzed within this work.

The DfM/DfA environment (GUI) is the core of the entire system with two primary purposes: (i) visualization/assessment and (ii) interaction with the CAD tool. The visualization/assessment module concerns the possibility of displaying validated and non-validated DfM/DfA design rules and assessing manufacturing and assembly KPIs (i.e., costs). The CAD feature recognition system links the DfM/DfA environment and the 3D CAD tool. It allows displaying in which feature the rule fails, and so where the designer can make design changes on the model. This stage deals with executing the DfM/DfA design rules for which any part is analyzed to check whether it satisfies the rules. DfM/DfA rules DB is part of the KB system. It is connected with the CAD feature recognition system to display, within the DfM/DfA environment, validated and non-validated rules and manufacturing and assembly KPIs.

CAD-integrated Design for Manufacturing and Assembly in mechanical design has many complex ontological relations summarised in this paper and reported in the following sections.

### 3.3 KB system

The KB approach aims to classify the DfM/DfA rules. The method for classifying these rules grounds on three main pillars: (i) *knowledge acquisition*, (ii) *knowledge processing*, and (iii) *knowledge representation*. This classification is the ontology representation of the KB system.

*Knowledge acquisition* refers to the review of technical documents (handbooks, reports, thesis) and the investigation of industry best practices for the collection of heterogeneous DfM/DfA design rules. In particular, this phase consists of two main tasks: (i) the collection of unstructured design rules for several manufacturing and assembly technologies (string data), and (ii) the identification of geometric entities (CAD features) and numerical parameters involved in the design rules (numerical data). *Knowledge processing* refers to the link between the DfM/DfA design rules previously collected during the knowledge acquisition phase and the geometric features of a virtual 3D model (CAD file). This phase is essential to transform a tacit knowledge (DfM/DfA rules list) into a systematic design review of the product (explicit knowledge). *Knowledge representation* refers to the definition of a structured repository for collecting and formalizing DfM/DfA knowledge. This phase encompasses the logical description of DfM/DfA design guidelines (syntax) and related information (e.g., suggestions about design changes to guarantee product manufacturability and assemblability).

#### 3.3.1 Knowledge acquisition phase

The knowledge acquisition phase begins by analyzing the available documents (e.g., books, research papers, technical reports, master/Ph.D. thesis) related to the DfM/DfA topic where tacit and unstructured knowledge is stored. In particular, in this research work, the following handbooks were investigated and reported in the references section: (i) Boothroyd, Dewhurst, and Knight (2010), (ii) Bralla (1999), (iii) Caimbrone (2007), and (iv) Poli (2001). It is worth noting that for some handbooks, DfM/DfA rules are already available as a list of actions about what to do and what is better to avoid during the design phase of a mechanical component. On the other hand, the DfM/DfA rules are not explicitly stated for some other authors, and a more in-depth analysis is necessary to extract applicable design rules. With the same aim and following the same approach, technical reports from manufacturing industries and thesis were analysed to retrieve DfM/DfA rules. Another essential source for the acquisition of DfM/DfA rules concerns the use and the access to the available documentation of commercial tools developed for DfM/DfA analysis (i.e., DFMA® tool from BOOTHROYD DEWHURST, Inc. and DFMPro® from HCL Technologies Ltd.). Besides, the authors organized several meetings in design departments of manufacturing companies to collect best practices and rules dedicated to given manufacturing technologies.

### 3.3.2 Knowledge processing phase

The knowledge processing phase begins with defining and classifying DfM/DfA rules associated with given manufacturing technology. This phase aims to create an ontology (i.e., structuring and formalizing data into hierarchies and classes to establish the relations between the data required for efficient machine processing) that is a comprehensive description of the domain of interest (DfM/DfA rules) concerning the users' needs. Table 1 presents the overall structure of the repository used for collecting and storing the rule-related information. Two examples facilitate understanding of the type of information to keep for each section. The structure of the repository is the semantic (logic) used to switch from tacit knowledge (unstructured) to explicit knowledge (structured). The repository stores rule based on the rule number, which is a positive, progressive number. It contains three areas: (i) *Manufacturing technology*, recalling the technological aspects (i.e., manufacturing technology class and manufacturing process type) related to a given rule, (ii) *Material*, providing material information (i.e., material class and material type) of a given rule, and (iii) *CAD feature recognition*, identifying geometric parameters and thresholds associated to a given rule. In addition to these sections, information about rule type is stored (i.e., info, warning, critical).

[INSERT TABLE 1 HERE]

Concerning the first section of the knowledge processing phase, classification of manufacturing technologies requires the definition of three clusters: (i) manufacturing technology class (e.g., machining, sheet metal stamping, metal forming, metal casting, plastic forming, welding, assembly), (ii) manufacturing technology type – level I (e.g., turning and milling for the machining class), and (iii) manufacturing technology type – level II (e.g., drilling, for milling type – level I). The adoption of these clusters is necessary to classify DfM/DfA rules that are generic for a technology class (e.g., machining) or specific for a manufacturing operation of the defined technology class (e.g., drilling). Indeed, a DfM/DfA rule may be valid for the generic manufacturing technology class (e.g., machining) regardless of the specific operation (e.g., turning, milling, drilling). In this case, the two levels or only the second level related to the manufacturing technology type are not specified (N.A. – Not Applicable). Conversely, a DfM/DfA rule may be valid only for a specific operation (e.g.,

drilling) and cannot be generalized for the manufacturing technology class that contains the operation (e.g., machining) as described in the first rule of Table 1. The identification of two levels for manufacturing technology type allows classifying DfM/DfA rules based on a list of operations (e.g., turning) or for a single operation (e.g., drilling, external cylindrical turning, internal cylindrical turning).

Concerning the second section of the knowledge processing phase, classification of materials requires the definition of two clusters according to Ashby (1999) classification: (i) material class (e.g., Carbon steel, Stainless steel, Aluminium alloy), and (ii) material type (e.g., AISI 304, 34NiCrMo16). These two groups allow allocating a given DfM/DfA rule to a generic class (e.g., stainless steel) or a specific type (e.g., AISI 304) of materials. The identification of these two clusters allows classifying DfM/DfA rules that are valid for any material (N.A. – Not Applicable), for a given material class (e.g., stainless steel), or for a given material type (e.g., AISI 304).

Concerning the third and last section of the knowledge processing phase, the classification of geometrical parameters and thresholds deals with 3D CAD features to recognize concerning a given DfM/DfA rule. Authors defined three clusters: (i) 3D CAD features (e.g., hole, slot), (ii) PMI – Product Manufacturing Information to read (e.g., roughness, tolerances), and (iii) dimension/geometry and rules to verify (e.g., hole diameter, hole length, hole length/diameter ratio). Feature recognition systems may extract, from a 3D virtual model, CAD features and the related data for the computational phase. It is worth mentioning that the current work refers to the type of feature to be recognized (i.e., through-hole) and related parameters (i.e., hole diameter and hole length) that can be read by the analysis of a 3D model (B-rep representation). Figure 3 reports an example of few extracted manufacturing features from a 3D CAD model.

**[INSERT FIGURE 3 HERE]**

In addition to these clusters, another item characterizes the rule: the *rule type*. This attribute may assume the following values: (i) info, (ii) warning, and (iii) critical. Info is a sort of recommendation that would be desirable (nice to have). Still, it does not affect the processing of the component and its cost. A warning is an important aspect to address since it generates a waste of manufacturing time and cost. Still, it does not prevent component manufacturability. Critical is the most significant rule, which means that stop the component manufacturability.

### **3.3.3 Knowledge representation phase**

The knowledge representation phase begins with the definition of a pre-defined form for each DfM/DfA rule. Indeed, a taxonomy and a syntax are necessary to keep consistency among different guidelines and provide the same level of details and information that the mechanical designer can manipulate during the product development process. Indeed, DfM/DfA guidelines syntax requires necessary and optional information. Necessary information provides the minimum set of data to perform a design improvement. The data are: (i) the design action to do (verb), and (ii) the subject which requires modification (name). Optional information provides additional data that allows clarifying the context in which the design action is needed. Such data are: (i) the manufacturing process, (ii) the type of feature involved, (iii) the type/family part, and (iv) the type of material. To give a detailed understanding of the DfM/DfA design rule, Figure 4 presents the DfM/DfA guideline syntax with a couple of examples and an explanatory picture illustrating what to do and what to avoid (DfM/DfA guideline picture).

[INSERT FIGURE 4 HERE]

### 3.4 CAD feature recognition method

Feature recognition is the procedure used for extracting features from a geometric model. As illustrated in Figure 2, through this step, it is possible to retrieve information from a 3D CAD model and to connect product features with the DfM/DfA design rules.

A feature recognition procedure begins by defining the types of features to be identified. Nowadays, a shared methodology for feature classification is still missing because it depends on the application scenario (Sanfilippo and Borgo 2016). In the past, researchers defined multiple categories of features that have been used in this paper for realizing a feature recognition framework. Figure 5 illustrates the types of features used in this research and their relationships. The first three features refer to the application of DfM rules related to part manufacturing. The last feature refers to applying DfA rules for product assembly.

- *Component feature*: this feature represents components (e.g., screw, nut shaft) (Staub et al. 2003). It describes the most relevant characteristics of a component, such as material (i.e., material feature), mass, volume, and area. There is only one feature for each component;
- *Geometric feature*: this is a specific kind of form feature (i.e., a feature that embodies elements characterized via shape properties) used for representing general manufacturing (both subtractive and additive) and operation (e.g., hole, pocket, slot, thread) features (Sanfilippo and Borgo 2016). It describes a specific manufacturing feature through its type, list of faces, properties, volume, etc. There is one or many features for each component;
- *Interaction feature*: this is a feature (definition rearranged from Nasr [2006]) determined by the interaction of two or multiple geometric features (e.g., neighbouring hole and bend on sheet metal). It describes the geometric relationships (e.g., distance, overlapping) between adjacent features. There could be none or multiple interaction features for each component. Each interaction feature is made of two or many geometric features;
- *Assembly feature*: this is a specific kind of form feature that is functional to assemble different components (e.g., screw/hole, belt/pulley) (Sanfilippo and Borgo 2016). It describes a specific assembly feature through its type, list of properties, etc. There is at least one feature for each assembly that joins two or multiple components.

[INSERT FIGURE 5 HERE]

Component features can be extracted from a 3D geometry (B-rep model – boundary representation) because attributes included in this class are readily available. Geometric and assembly features can be extracted from a 3D model by using specific software tools for geometric feature recognition (e.g., SolidWorks by Dassault Systemes has a module for feature recognition) or for analytical process and cost estimation (e.g., LeanCOST by Hyperlean has a kernel for manufacturing and assembly features recognition). Such tools can compute manufacturing and assembly features for a comprehensive set of component shapes (e.g., prismatic, axisymmetric, sheet metal) and assemblies (e.g., welded structures mounted assemblies). It is possible to watch the most relevant attributes expected for further DfM rules processing for each feature.

At last, interaction features can be identified by manually browsing manufacturing features and coupling those interrelated ones (it was not recognizable a tool readily available for detecting this kind of features). It is worth noting that native files can be used for this analysis as well as new exchange formats such as the STEP AP242, known as Managed Model-Based 3D Engineering (ISO 10303). STEP AP242 is a product data exchange file that ensures interoperability between CAD systems and downstream applications such as manufacturing and inspection, keeping all the PMI (Product and Manufacturing Information) defined by designers in the native CAD model. PMI includes annotations to specify Geometric Dimensioning and Tolerancing (GD&T), as well as non-geometric data such as surface texture specifications, finish requirements, process notes, material specifications, and welding symbols. When different exchange formats are used, if some data (features or PMI) is lost, they should be re-defined later by the designer.

#### **3.4.1 Component features**

The first kind of feature refers to the physical characteristics of the overall model to recognize for applying those rules concerning the part manufacturing. In particular, the features to identify within this cluster are: (i) material type, (ii) volume of the part, (iii) mass, and (iv) area/surface of the part. This kind of feature is retrieved by querying the CAD model and considering the overall part. Figure 6 presents an example (3D model of a flange) of the features recognized by this analysis.

[INSERT FIGURE 6 HERE]

#### **3.4.2 Geometric features**

The geometric features (also commonly called manufacturing features) of a model contains the following information: (i) type of feature, (ii) coordinate of the feature about the origin (i.e., the centre of gravity of the bounding box), (iii) properties of the feature, (iv) volume of the feature, (v) area of the feature, (vi) faces of the feature, and (vii) PMI – Product Manufacturing Information. It is worth noting that PMI includes surface roughness as well as tolerances, both dimensional and geometrical. This kind of feature is retrieved by querying the CAD model considering the overall part. Figure 7 presents an example (3D model of a flange) of the features recognized by this analysis.

[INSERT FIGURE 7 HERE]

#### **3.4.3 Interaction features**

The third kind of feature (interaction features) expresses the relations among the different geometric features of the model. It is still related to the application of DfM rules for part manufacturing. In this feature recognition analysis, each feature of the model must be investigated against the other features (features relation). Therefore, the following information is required: (i) type of feature vs. types of features, (ii) coordinates of the feature vs. coordinates of the features, and (iii) properties of the feature vs. properties of the features. Concerning the item “properties of the feature vs. properties of the features” only dimensional constraints are involved, and no geometrical tolerances (the latter are considered within the geometric features). This kind of feature is retrieved by querying the CAD model considering the overall part. For the

sake of brevity, Figure 8 presents the relationships existing for a specific feature (i.e., the minimum distance between the edges of the adjacent hole and fillet/chamfer).

[INSERT FIGURE 8 HERE]

#### 3.4.4 Assembly features

The fourth feature refers to the relation among the different geometric entities belonging to two or more components in an assembly. In this feature recognition analysis, a given feature of a model (component) needs to be investigated against features of other models (components) that are composing the same assembly (features relation). The following set of information is required: (i) type of feature vs. types of features, (ii) coordinates of the feature vs. coordinates of the features, and (iii) properties of the feature vs. properties of the features. This kind of feature is retrieved by querying the CAD model (assembly) considering all the parts composing the model. In this case, for the sake of brevity, Figure 9 presents only an example of the features recognized for a given part vs. another feature of a different part (Feature\_3 – circular hole pattern (flange\_1) vs. Feature\_1 – cylindrical pad (hexagonal bolt\_1)).

[INSERT FIGURE 9 HERE]

### 3.5 KPIs assessment in DfM/DfA

The KPIs related to DfM and DfA are, respectively, the manufacturing and assembly costs. Among the methods employed for manufacturing and assembly cost estimation (i.e., intuitive, analogic, parametric, and analytic), the analytic one allows product costs to be broken down into elementary manufacturing and assembly operations. This method guarantees high reliable cost estimates, but it requires a proper set of knowledge. Hereunder the approach used for estimating the manufacturing and assembly cost. The present method is based on previous works concerning manufacturing (Mandolini et al. 2020) and assembly (Boothroyd, Dewhurst, and Knight 2010). Here follow the paper presents only the main features of these approaches. Detailed information is available in the relative full papers.

#### 3.5.1 Manufacturing cost

The manufacturing cost is commonly split down into six items, according to Mandolini et al. (2020):

- *Material*: costs of raw material necessary to produce a specific component (e.g., virgin material, scraps);
- *Machine*: cost of the production process performed by a machine;
- *Labour*: cost of the production process performed by an operator;
- *Equipment*: cost of the process enabling equipment (e.g., mould, jigs, fixtures);
- *Consumables*: cost of the process enabling materials (e.g., lubricant, tools);
- *Energy*: cost of energy vectors used during a manufacturing process (e.g., electricity, water, steam).

Such breakdown allows designers to be aware of the cost-related consequences of their design choices. The manufacturing cost estimation procedure is a sequence of six multiple steps from the 3D product virtual prototype (Mandolini et al.,



2020). Firstly, it computes the raw material and the manufacturing process, and then it estimates the manufacturing cost and related breakdown. The computation steps are: (i) definition of the overall production scenario, (ii) definition of the production strategy (the combination of raw material and manufacturing process), (iii) definition of the raw material, (iv) definition of the manufacturing strategy, (v) definition of a bundle of operations connected to each manufacturing feature, and (vi) definition of the sequence of operations related to the whole manufacturing features.

The knowledge for manufacturing cost estimation consists of cost models and cost routings. A cost model is a data model containing the knowledge required for estimating the production time and cost for each operation. A cost routing is defined as a hierarchical data model of five constructs (Mandolini et al., 2020), each containing sets of attributes and rules for generating manufacturing processes from 3D virtual prototypes of components.

### **3.5.1 Assembly cost**

Based on (Boothroyd, Dewhurst, and Knight 2010), the assembly cost estimation procedure is a bit different from that used for manufacturing cost. It consists of firstly defining the assembly sequence by analyzing physical liaisons and assembly precedence among components. Secondly, it entails the estimation of the assembly time for each component, which is the sum of five contributions: (i) acquisition, (ii) movement, (iii) orientation, (iv) insertion, and (v) fastening. The assembly time depends on multiple factors that affect the assembly steps above-mentioned. For example, the part symmetry, thickness, size, weight, chamfer dimension, decreased vision, and fixturing tools are typical factors that influence the overall assembly time. According to empirical measurements and geometric considerations, the acquisition, movement, orientation, insertion, and fastening times can be separately or jointly related to these factors. This approach allows designers to estimate the assembly time of a component considering its actual conditions within an assembly. For this aim, Boothroyd, Dewhurst, and Knight (2010) defined proper classification systems for establishing the relationships among part features and manual handling, insertion, and fastening time. In addition to these classification systems, Boothroyd et al. also proposed equations and graphs for estimating the assembly time according to the most critical part features.

## **4. Case studies**

In this section, the proposed CAD-integrated DfM/DfA methodology was used to address possible manufacturing issues in mechanical components and assembled products. Two case studies were presented: the first one is a simple casing based on six parts, while the second one is a pump made of sixty-eight components. A detailed procedure of the proposed method is described for the first example. In contrast, only a description of the main issues highlighted for the second example is reported showing the feasibility in method application for a more complex assembly.

### **4.1 Case study 1: casing assembly**

The first case study was used to perform DfM/DfA analysis by using 3D CAD models of six components (parts) and one product (assembly) (Figure 10 shows the exploded view and BoM of the case study):

- Component #1: one milled block part of aluminum alloy 1060 (base.stp).
- Component #2: one milled plate part of aluminum alloy 1060 (lid.stp).
- Component #3: four screws M10 used to connect the base and the lid parts (screw.stp).

- Assembly: one casing assembly that includes the base, the lid, and the screws (assembly.stp).

Each CAD model must be provided with 3D annotations. According to these annotations, the dimensional and geometric constraints of each feature are identified and extracted as inputs. For this exercise STEP AP242, known as Managed Model-Based 3D Engineering, was used as input.

**[INSERT FIGURE 10 HERE]**

The case study has been modelled by the authors of this work to cover the four different types of recognizable features and to understand the potential benefits and drawbacks of the method in real applications. This case study contains various design issues, which are summarized in Table 2. DfM analysis was performed for the milled parts, both lid (lid.stp) and base (base.stp), while DfA was applied to the overall assembly (assembly.stp).

**[INSERT TABLE 2 HERE]**

By following the proposed approach, the first step concerns the 3D model data reading as described in the methodology workflow (Figure 1). The described CAD feature recognition system was used to retrieve information from the 3D CAD model and connect product features with the DfM/DfA guidelines. Appendix A (Table 6) summarizes the first three features (i.e., component, geometric, and interaction features) considering the part (lid.stp) manufactured with milling technology (machining). Appendix A (Table 7) presents the assembly features for the manual assembly (assembly.stp) using bolts.

Once identified the features, during the second step, *DfM/DfA rules analysis* was performed as described in the methodology workflow (Figure 1). Only the set of DfM rules referring to machining (milling) technology was selected for the part analysis. Then, explicit knowledge characterizing each DfM rule is checked with the feature identified in the feature recognition phase. Appendix B (Table 10) reports a set of rules dedicated to the milling process. It is worth noting that this is not a complete list of rules but only part of it.

In the case of assembly analysis, only the set of DfA rules that refers to manual assembly (bolted) were selected. Then, thresholds of parameters characterizing each DfA rule are checked to the features identified in the feature recognition phase. Appendix B (Table 11) reports a set of rules dedicated to the manual assembly process. Again, it is worth noting that this is not a complete list of rules but only an extract.

Within the rules analysis phase, four design issues were addressed regarding the lid part (DfM) and one design issue regarding the assembly (DfA). For the lid example, design issues belong to the different features. The first issue concerns the amount of material wasted to make the component (i.e., rule #1 of Table 10). This manufacturing issue is related to the component features. In this case, the starting point of the manufacturing process is a raw plate of dimensions 106mm x 56mm x 12mm (length x Width x Thickness) with a volume of 71232 mm<sup>3</sup>. This initial volume is approx. 2.6 times higher than the volume of the finished part (27054.20 mm<sup>3</sup>). As a manufacturing rule for parts produced by machining operations, the ratio between the volume (or weight) of the starting raw and the volume (or weight) of the finished part must be kept the lowest possible and at least two times the raw material. This rule is an essential guideline for avoiding

unnecessary raw material costs, which have no added value. This issue can be classified as a warning since it generates waste of manufacturing time and cost. Still, it does not negatively affect component manufacturability.

The following two design issues refer to geometric features. The second design issue concerns the external sharp edges within the component (i.e., rule #10 of Table 10). Outer sharp edges must be avoided when they are not functional for the part. The external sharp edge in a milled part generates a series of problems, such as handling difficulties. A sharp edge is a stress point causing reduced useful life. Thus, the DfM guideline avoids external sharp edges when not expressly required by the project (use fillets or chamfers). This issue can be classified as a recommendation that would be desirable (nice to have) and does not significantly affect the processing of the component and its cost. In particular, a contouring operation is required for the perimeter of the component. The addition of one or more external fillets does not affect the cost of the operation.

The third design issue is classified as critical, and it affects the technological feasibility of the feature. This issue refers to the internal corners which must be rounded in milling processes (i.e., rule #3 of Table 10). The use of rounded inner corners provides a series of advantages, including a lower concentration of stress and all fewer machine operations, time savings, and reduction of processing waste. Indeed, sharp internal edges cannot be obtained by milling, and they require more complicated and expensive technologies such as Electrical Discharge Machining (EDM).

The fourth design issue belonging to part manufacturing is related to the interaction features. This issue concerns the pattern of holes and the slot that are too close to the external edges of the component. This situation determines thin sections (i.e., rule #7 of Table 10). For this reason, the design guideline suggests having at least 3 mm of a minimum gap between the edge of the part (free edge) and the edge of a surface for the holes and slot. Indeed, this issue is related to two different features of the same model: (i) Feature\_3 – HOLE RECTANGULAR PATTERN vs. Feature\_1 – PAD and (ii) Feature\_2 – SLOT vs. Feature\_1 – PAD. In both cases, the distance between the free edge and the hole/slot is less than 3 mm. This issue is classified as a warning.

For the assembly example, the design issue is related to the assembly features. In particular, the problem refers to a minimum diameter gap required between screw and hole of non-threaded parts of bolted connection (i.e., rule #2 of Table 11). This minimum gap is necessary to facilitate screw insertion and avoid possible stuck in manual assembly operations. A minimum diameter gap is quantified in 1 mm (for M10 screw). It can be assessed by the difference between the hole diameter (in the lid part) and the external screw diameter (in the screw part). This issue involved the following features: (i) Feature\_3 – HOLE RECTANGULAR PATTERN (lid) and (ii) Feature\_1 – CYLINDRICAL PAD (screw). Table 3 summarises the identified design issues concerning the features recognition from the 3D CAD model. All the other features that fulfill the design guidelines are not reported within this table.

**[INSERT TABLE 3 HERE]**

For the retrieved DfM/DfA guidelines that are not compliant (i.e., non-validated DfM/DfA design rules) within the proposed exercises, an analytical cost estimation has been done starting from the identified features. At this stage, DfM/DfA KPIs calculation is performed (third step) as described in the methodology workflow (Figure 1).

Table 12 in Appendix C. summarises the manufacturing costs of the lid and the cost for the overall assembly. It is important to notice that the assembly cost estimation is not applicable in the original design due to the interference

between screws and holes of the lid part. Thus, it is not possible to insert the screws within the lid. Based on the mentioned analyses (3D model data reading, DfM/DfA rules analysis, and DfM/DfA KPIs calculation), a report was generated – *DfM/DfA report generation* – as described in the fourth step of the methodology workflow (Figure 1). This report keeps track of the changes made about the CAD model and its evolutions over time. At this step, the designer tries to fix the previously highlighted issues, preparing an updated 3D model (it has to respect the technical specifications) by changing the model features according to the design guidelines. The *3D model update* is the fifth step of the presented methodology described in the methodology workflow (Figure 1).

Concerning the “lid.stp” component, the changes consisted of:

- Feature\_1 – PAD: removed the external sharp edges using a 4 mm fillet radius.
- Feature\_2 – SLOT: removed the internal sharp edges using a 4 mm fillet radius.
- Feature\_2 – SLOT vs. Feature\_1 – PAD: increased the minimum distance between slot and edge through a slot reduction. Now the distance between the features is 4 mm instead of 2,5 mm.
- Feature\_3 - HOLE RECTANGULAR PATTERN vs. Feature\_1 – PAD: increased the minimum distance between holes and edge through a hole’s diameters reduction (6 mm instead of 10 mm). This type of modification is possible using M5 screw instead of M10 screw, which, however, can respect the structural constraints of the assembly. Now the distance between the two features is 4,5 mm instead of 2,5 mm. Besides, a diameter gap of 1 mm for assembly is achieved through this modification. This modification is also related to the assembly. In fact, using larger holes, screw insertion is more straightforward, allowing its insertion through the lid part.

Table 8 in Appendix A. summarises the first three kinds of features considering the modified part (lid\_mod.stp) manufactured with milling technology (machining). Table 9 summarises the fourth kind of feature for the manual assembly (assembly\_mod.stp) using bolted joints.

Table 13 in Appendix C. reports the KPI (cost-sharing) for the component manufacturing and the product assembly after the modifications. The case study highlights the significant manufacturing cost reduction of the lid component. The fillet radius of the internal corner of *Feature\_2 – SLOT* was increased to 4 mm. Thanks to this modification, the EDM operation is no longer necessary. The manufacturing cost of this component is approximately three times less than the initial project (10,33 € vs. 3,79 €). Another significant modification of the lid part is related to the hole diameter of *Feature\_3 – HOLE RECTANGULAR PATTERN* and the augmentation of the screws-holes distances in assembly.

## 4.2 Case study 2: centrifugal pump

The second case study wants to analyse an actual product, a centrifugal pump made of 68 components (parts) and one product (assembly) (Figure 11 shows the exploded view and Table 4 shows the BoM of the case study):

[INSERT FIGURE 11 HERE]

[INSERT TABLE 4 HERE]

Once identified the features of the parts and the assembly, DfM/DfA rules analysis was performed as described in the methodology workflow. Then, mathematical equations characterizing each DfA rule are checked with the feature

identified in the feature recognition phase. This case study identified 11 design issues regarding the assembly related to the assembly recognition of geometric feature recognition.

The first design issue is classified as critical, and it affects the assembly feasibility. In particular, the problem refers to a minimum diameter gap required between screw and hole of non-threaded parts of bolted connection. This minimum gap is necessary to facilitate screw insertion and avoid possible stuck in manual assembly operations. A minimum diameter gap varies in function of screw dimensions. It can be assessed by the difference between the hole diameter and the external screw diameter. This issue involved the following features:

- Feature\_1 – HOLE CIRCULAR PATTERN (Bearing cover) and Feature\_1 – CYLINDRICAL PAD (Hex head screw ISO 4017 M6 x 25). Minimum required diameter gap: 0,6 mm. Actual diameter gap: 0 mm.
- Feature\_1 – HOLE BASE (House bearing) and Feature\_1 – CYLINDRICAL PAD (Hex head screw ISO 4016 M10 x 45). Minimum required diameter gap: 1 mm. Actual diameter gap: 0 mm.
- Feature\_2 – HOLE CIRCULAR PATTERN (House bearing), Feature\_8 – HOLE CIRCULAR PATTERN (Coupling), and Feature\_1 – CYLINDRICAL PAD (Stud ISO 888 M8 x 85). Minimum required diameter gap: 0,8 mm. Actual diameter gap: 0 mm.
- Feature\_1 – HOLE LINEAR PATTERN (Packing gland) and Feature\_1 – CYLINDRICAL PAD (Stud ISO 888 M8 x 85). Minimum required diameter gap: 0,8 mm. Actual diameter gap: 0 mm.

The second design issue is classified as a warning since it does not affect the assembly feasibility but increase time and difficulty. This issue is due to the absence of bevels around the holes to facilitate screw insertion. It is always advisable to provide entry holes with chamfered/countersunk ends. This condition facilitates the screw insertion into the hole.

This issue involved the following features:

- Feature\_1 – HOLE CIRCULAR PATTERN (Bearing cover), Feature\_3 – THREADED HOLE CIRCULAR PATTERN (House bearing) and Feature\_1 – CYLINDRICAL PAD (Hex head screw ISO 4017 M6 x 25).
- Feature\_1 – HOLE BASE (House bearing) and Feature\_1 – CYLINDRICAL PAD (Hex head screw ISO 4016 M10 x 45).
- Feature\_2 – HOLE CIRCULAR PATTERN (House bearing), Feature\_8 – HOLE CIRCULAR PATTERN (Coupling), Feature\_1 – HOLE CIRCULAR PATTERN (Casing) and Feature\_1 – CYLINDRICAL PAD (Stud ISO 888 M8 x 85).
- Feature\_1 – HOLE LINEAR PATTERN (Packing gland), Feature\_10 – THREADED HOLE LINEAR PATTERN (Coupling) and Feature\_1 – CYLINDRICAL PAD (Stud ISO 888 M8 x 85).

The third design issue is classified as information. It is referred to the use of combined fasteners, e.g., screws with integrated washers, to reduce assembly times.

This issue involved the following components:

- Stud ISO 888 M8 x 85, plain washer ISO 7089 M8, and nut DIN ISO 4032 M8 to connect casing (2) and coupling (5).
- Stud ISO 888 M8 x 85, plain washer ISO 7089 M8, and nut DIN ISO 4032 M8 to connect packing gland (9) and coupling (5).

- Nut DIN ISO 4032 M10, plain washer ISO 7089 M10, and hex head screw ISO 4016 M10 x 45 to connect house bearing (20) and support (22).

Concerning DfM analysis, this is carried only for the coupling.stp component (component #5). This component is a milled part from a round block (with a raw material diameter of 200 mm) of stainless steel (AISI 316). In addition to the assembly issues described above relating to the DfA analysis, the only manufacturing issue concerns the threaded hole linear pattern. This feature is composed of two M8 threaded holes 56 mm in length. As information (nice to have), it is recommended to reduce the length of the threaded section to values smaller than two times the diameter of the hole in the case of both blind and through threaded holes. Screw length higher than two does not increase the mechanical strength of the joint but can instead lead to problems during processing with possible breakages and damage to the tapping tool and an increase in the cost of machining. This rule is significant for small diameters (less than 6 mm).

Table 5 summarises the identified design issues concerning the features recognition from the 3D CAD model. All the other features that fulfill the design guidelines are not reported within this table.

**[INSERT TABLE 5 HERE]**

At the same time, with DfM/DfA rules analysis, an analytical cost estimation has been done starting from the identified features. Table 14 in Appendix C. summarises the manufacturing cost of the coupling and the cost for the overall assembly. It is important to notice that the assembly cost estimation is not applicable in the original design due to the interference between screws and holes of the parts. Thus, it is not possible to insert the screws and complete the assembly. At this step, the previously highlighted issues will be fixed. Then the 3D model is updated by changing the model features according to the design guideline.

The list of changes are reported here below and consisted of:

- Feature\_2 – HOLE CIRCULAR PATTERN (House bearing): increasing of hole diameters from 8 mm to 9 mm (Feature\_2 – HOLE CIRCULAR PATTERN\_MOD (House bearing)).
- Feature\_2 – HOLE CIRCULAR PATTERN\_MOD (House bearing): new chamfering feature needed for easier screw insertion.
- Feature\_8 – HOLE CIRCULAR PATTERN (Coupling): increasing of hole diameters from 8 mm to 9 mm (Feature\_8 – HOLE CIRCULAR PATTERN\_MOD (Coupling)).
- Feature\_8 – HOLE CIRCULAR PATTERN (Coupling): new chamfering feature needed for easier screw insertion.
- Feature\_10 – THREADED HOLE LINEAR PATTERN (Coupling): new chamfering feature needed for easier screw insertion.
- Feature\_1 – HOLE BASE (House bearing): increasing of hole diameters from 10 mm to 11 mm (Feature\_1 – HOLE BASE\_MOD (House bearing)).
- Feature\_1 – HOLE BASE\_MOD (House bearing): new chamfering feature needed for easier screw insertion.

- Feature\_1 – HOLE CIRCULAR PATTERN (Bearing cover): increasing of hole diameters from 6 mm to 7 mm (Feature\_1 – HOLE CIRCULAR PATTERN\_MOD (Bearing cover)).
- Feature\_1 – HOLE CIRCULAR PATTERN (Bearing cover): new chamfering feature needed for easier screw insertion.
- Feature\_1 – HOLE LINEAR PATTERN (Packing gland): increasing of hole diameters from 8 mm to 9 mm (Feature\_1 – HOLE LINEAR PATTERN\_MOD (Packing gland)).
- Feature\_1 – HOLE LINEAR PATTERN\_MOD (Packing gland): new chamfering feature needed for an easier screw insertion.
- Replacement of the nuts (Nut DIN ISO 4032 M8), washers (Plain washer ISO 7089 M8) and studs (Stud ISO 888 M8 x 85) with flanged screws (Hex head screw DIN 6921 M8 x 65 and Hex head screw DIN 6921 M8 x 60).
- Replacement of the nut (Nut DIN ISO 4032 M10), washer (Plain washer ISO 7089 M10), and screw (Hex head screw ISO 4016 M10 x 45) with a flanged nut (Nut DIN ISO 4161 M10) and a flanged screw (Hex head screw DIN 6921 M10 x 40)).
- Lowering the starting surface of the coupling holes in Feature\_10 – THREADED HOLE LINEAR PATTERN (Coupling) and thus obtaining a threaded section of 15 mm.

Figure 12 shows the difference between the original design (left) and the updated design (right) of the coupling, highlighting the treaded hole feature in orange.

**[INSERT FIGURE 12 HERE]**

Table 15 in Appendix C. reports the KPI (cost-sharing) for the component manufacturing and the product assembly after the modifications. This case study highlights the manufacturing cost reduction of the coupling component. The threaded length of Feature\_10 – THREADED HOLE LINEAR PATTERN (Coupling) was decreased to 15mm (instead of 56 mm). Thanks to this modification, the manufacturing cost of this component decreased approx. by 5% (204,84 € vs. 196,49 €).

Table 15 in Appendix C. also reports the cost-sharing for the assembly after the design update. It is possible to notice that the major costs are related to the screw insertion and bearing mounting (1,47 € + 4,40 € + 4,40 € + 1,10 €). In the updated version of the assembly design, it is important to underline that the overall number of the parts has been reduced from 68 to 46, thanks to combined fasteners.

## 5. Discussion

The proposed approach enables the following features: (i) the identification of product design issues in 3D CAD models, (ii) the analysis of the rules propagation in the CAD design environment, and (iii) the distribution of “know-how” to designers in the context of their specific design activity (explicit knowledge). This work encompasses several disciplines such as manufacturing knowledge classification, 3D model feature recognition, and computational analysis, including the

possibility to develop a software tool extending the current CAD capabilities. The adoption of the proposed approach highlights several interesting outcomes both for scholars and industrial practitioners. The first one is related to the effort and time required for developing manufacturing and assembly-compliant products. With this approach, design review loops may be reduced, thus improving the product time-to-market. Another interesting outcome concerns the possibility of sharing manufacturing knowledge across design team members and reusing it each time it needs.

The case studies presented in this paper refer to a couple of products: a simple assembly made of few components and a pump composed of 68 parts. Concerning the first case study, the four types of recognizable features are considered providing a complete example of the method. In contrast, with the second one, potential benefits of the method in a real application are shown. The first case study highlighted four design issues related to the lid part and base part (DfM) and one design issue regarding the assembly (DfA). All types of features are involved in this example: component, geometric, interaction, and assembly features. The modification of design issues allows a significant cost reduction in the lid part (approximately three times less than the initial project) and the possibility to perform the assembly task, which was unfeasible in the original design. The second case study concerns the design analysis of a centrifugal pump. This example contains several design issues, both from the assemblability and manufacturing sides. DfA analysis shown 11 design problems regarding the product assembly, including critical, warning, and information. If in the original design product assembly was unfeasible due to the absence of minimum diameter gap required between screw and hole of non-threaded parts of bolted connection, changing the parameters of the 3D CAD model referring to the non-compliant features, the assembly task can now be performed. On the other hand, by changing warning design issues, the assembly process can be made easier, thanks to the chamfered/countersunk insertion holes which facilitate screw insertion. At the same time, by solving the issue referred to the information design rules (use of integrated washer bolt), it will be possible to reduce assembly times and the number of components (68 vs. 46).

DfM analysis was applied only for the coupling (component #5) part, highlighting one manufacturing design issue related to the threaded holes Feature\_10 – THREADED HOLE LINEAR PATTERN. By decreasing their length from 56 mm to 15 mm, the component cost decreasing approx. by 5% (204,84 € vs. 196,49 €). This case study demonstrates that the method is also applicable for components with a higher quantity of geometric features with complex shapes and assemblies made of many parts. The increasing complexity required for managing such products, push research toward the adoption of algorithms and software tools for automating the methodology presented in this paper (e.g., software integrated with a 3D CAD system).

## **6. Conclusions**

Process planning and engineering design for mechanical products are concurrent processes requiring collaboration among all parties to optimize the project outcomes such as cost, quality, performance, and reliability. The increasing competitiveness of the markets is pushing designers to develop more and more competitive products. For this aim, designers must follow a growing number of design tips and rules, but the problem concerns finding the set of rules to apply at the right time. Thus, the proposed CAD-integrated Design for Manufacturing and Assembly Framework aims to capture, retrieve and suggest design rules according to a given design context. In this paper, a CAD-integrated Design for Manufacturing and Assembly methodology allows making accessible manufacturability knowledge within the design phase (3D modelling).



The approach presented in this paper is the backbone of a software tool for virtual assisting designers in evaluating possible design inconsistencies with manufacturing processes. With regards to this advantage, there is the possibility to use the proposed approach for teaching initiatives and to educate the young generation of designers with a learning-by-doing system. Indeed, the learning curve of this new generation of engineers and designers can be boosted up by the adoption of this method.

Few limitations were observed with the development of the proposed CAD-integrated Design for Manufacturing and Assembly framework. The first one concerns the update of the DfM/DfA rules DB, which requires the analysis of new documents to retrieve additional tacit knowledge that can be translated into explicit knowledge by using the proposed Knowledge-based system (rule insertion form). Another aspect that deserves further investigation concerns the definition of geometric features. To date, researches were focused on manufacturing features related to traditional (i.e., subtractive) manufacturing processes (e.g., hole, slot, pad, pocket, etc.). Since additive manufacturing technologies are widespread, future research for evaluating the impact these processes have on manufacturing features will be essential.

Due to the limitations mentioned above, future works will focus on three main topics: (i) enlarge DfM rules collection for emerging technologies with different challenges (i.e., coating, additive manufacturing), (ii) extend KPIs assessment to other design aspects (e.g., sustainability), and (iii) software implementation and development. Regarding the first topic, DfM rules for emerging technologies (i.e., additive manufacturing) and auxiliary manufacturing processes (i.e., coating, thermal treatments) must be retrieved and classified based on the described ontology. Feature recognition for additive manufacturing processes will be a challenging task due to the nature of this process. Indeed, traditional manufacturing processes consist of multiple and different operations (e.g., milling, drilling) connected to relative manufacturing features (e.g., hole, pocket, slot). A 3D printing process cannot be split down into multiple manufacturing features. This situation should lead scholars to deep dive into the definition of geometric features for such manufacturing technologies.

Regarding the second topic, as already proposed for the cost KPI, additional analytical models can be adopted to calculate other design requirements (e.g., environmental indicators, manufacturing time, de-manufacturing time). In this manner, it will be possible to consider multiple design targets (e.g., Design for Environment, Design for Manufacturing Planning, Design for Disassembly). Dedicated indices can be firstly identified (i.e., CO<sub>2</sub> emissions), then linked with analytical models for their calculation, and lastly connected to the features properties. Thus, other embedded CAD environments can be developed (CAD-integrated Design for X systems), providing a complete overview of the project requirements and life cycle performances.

Regarding the third and last topic, dedicated research activities to DB rules implementation and Graphic User interface are mandatory to provide a tangible software tool able to support design activities during 3D modelling. This future implementation will translate the proposed framework (Figure 2) into a software tool (software application). An important aspect is related to the possibility of displaying the rules within the CAD environment correctly. Furthermore, the implementation and embedment of a feature recognition kernel within the tool just mentioned will also leverage the usability of the DfM/DfA methodology. In this way, corrective design actions can be managed in real-time within the design process, and the tool can suggest changes to the 3D CAD model.

## References

- APriori 2021 - <https://www.apriori.com/> accessed on 08/06/2021
- Ashby, M.F. 2010. *Materials Selection in Mechanical Design*. 4th Edition . Butterworth-Heinemann.
- Boothroyd, G., P. Dewhurst, and W. Knight 2010. *Product Design for Manufacture and Assembly*, 3rd edition. Boca Raton. CRC Press.
- Bralla, J.G. 1999. *Design for Manufacturability Handbook*, Second Edition. The McGraw-Hill Companies.
- Campi, F., C. Favi, M. Mandolini, and M. Germani. 2019. "Using design geometrical features to develop an analytical cost estimation method for axisymmetric components in open-die forging". *Procedia CIRP* 84: 656-661. doi: <https://doi.org/10.1016/j.procir.2019.04.324>.
- Campi, F., M. Mandolini, C. Favi, E. Checcacci, and M. Germani. 2020. "An analytical cost estimation model for the design of axisymmetric components with open-die forging technology". *The International Journal of Advanced Manufacturing Technology* 110: 1869–1892. doi: <https://doi.org/10.1007/s00170-020-05948-w>.
- Chen, K.-H., S.J. Chen, L. Lin, and S.W. Changchien. 1998. "An integrated graphical user interface (GUI) for concurrent engineering design of mechanical parts". *Computer Integrated Manufacturing Systems* 11 (1-2): 91-112. doi: [https://doi.org/10.1016/S0951-5240\(98\)00016-0](https://doi.org/10.1016/S0951-5240(98)00016-0).
- Chhim, P., R.B. Chinnam, and N. Sadawi. 2019. "Product design and manufacturing process based ontology for manufacturing knowledge reuse". *Journal of Intelligent Manufacturing* 30: 905-916. doi: <https://doi.org/10.1007/s10845-016-1290-2>.
- Ciambrone, D. 2007. *Effective Transition from Design to Production*. Auerbach Publications.
- Debord, S., F. Segonds, R. Piquié, P. Veron, and N. Croué. 2018. "Proposition of a design rules framework". In proceedings of 25ème colloque des Sciences de la conception et de l'innovation - CONFERE 2018, Budapest, Hungary.
- DFMPRO 2021 - <https://dfmpro.com/> accessed on 08/06/2021
- DFMA 2021 - <https://www.dfma.com/> accessed on 08/06/2021
- Favi, C., M. Germani, and M. Mandolini. 2016. "A Multi-objective Design Approach to Include Material, Manufacturing and Assembly Costs in the Early Design Phase". *Procedia CIRP* 52: 251-256. doi: <https://doi.org/10.1016/j.procir.2016.07.043>
- Favi, C., M. Germani, and M. Mandolini. 2018. "Development of complex products and production strategies using a multi-objective conceptual design approach". *The International Journal of Advanced Manufacturing Technology* 95 (1-4): 1281-1291. doi: <https://doi.org/10.1007/s00170-017-1321-y>.
- Ferrer, I., J. Rios, J. Ciurana, and M.L. Garcia-Romeu. 2010. "Methodology for capturing and formalizing DFM Knowledge". *Robotics and Computer-Integrated Manufacturing* 26 (5): 420-429. doi: <https://doi.org/10.1016/j.rcim.2009.12.003>.

- Gao, J., D.T. Zheng, and N. Gindy. 2004. "Extraction of machining features for CAD/CAM integration". *The International Journal of Advanced Manufacturing Technology* 24: 573-581. doi: <https://doi.org/10.1007/s00170-003-1882-9>.
- Germani, M., P. Cicconi, and M. Mandolini. 2011. "Manufacturing cost estimation during early phases of machine design". Proceedings of the 18th International Conference on Engineering Design - ICED 11.
- Hayasi, M.T., and S. Asiabanpour. 2009. "Extraction of manufacturing information from design-by-feature solid model through feature recognition". *The International Journal of Advanced Manufacturing Technology* 44: 1191-1203. doi: <https://doi.org/10.1007/s00170-008-1922-6>.
- Holland, P., P.M. Standring, H. Long, and D.J. Mynors. 2002. "Feature extraction from STEP (ISO 10303) CAD drawing files for metalforming process selection in an integrated design system". *Journal of Materials Processing Technology* 125-126: 446-455. doi: [https://doi.org/10.1016/S0924-0136\(02\)00364-3](https://doi.org/10.1016/S0924-0136(02)00364-3).
- Hoque, A.S.M., P.K. Halder, M.S. Parvez, and T. Szecsi. 2013. "Integrated manufacturing features and Design-for-manufacture guidelines for reducing product cost under CAD/CAM environment". *Computers & Industrial Engineering* 66 (4): 988-1003. doi: <https://doi.org/10.1016/j.cie.2013.08.016>.
- LeanCOST 2021 - <https://hyperlean.eu/en/> accessed on 08/06/2021
- Letaief, M.B., M. Tlija, and B. Louhichi. 2020. "An approach of CAD/CAM data reuse for manufacturing cost estimation". *International Journal of Computer Integrated Manufacturing* 33 (12): 1208-1226. doi: <https://doi.org/10.1080/0951192X.2020.1815842>.
- Ma, H., X. Zhou, W. Liu, J. Li, Q. Niu, and C. Kong. 2018. "A feature-based approach towards integration and automation of CAD/CAPP/CAM for EDM electrodes". *The International Journal of Advanced Manufacturing Technology* 98: 2943-2965. doi: <https://doi.org/10.1007/s00170-018-2447-2>.
- Mandolini, M., F. Campi, C. Favi, M. Germani, and R. Raffaeli. 2020. "A framework for analytical cost estimation of mechanical components based on manufacturing knowledge representation". *The International Journal of Advanced Manufacturing Technology* 107: 1131-1151. doi: <https://doi.org/10.1007/s00170-020-05068-5>.
- Marconi, M., M. Germani, C. Favi, and R. Raffaeli. 2018. "CAD feature recognition as a means to prevent ergonomics issues during manual assembly tasks". *Computer-Aided Design and Applications* 15 (5): 734-746. doi: <https://doi.org/10.1080/16864360.2018.1441240>.
- Morbidoni A., C. Favi, and M. Germani. 2011. "CAD-Integrated LCA Tool: Comparison with dedicated LCA Software and Guidelines for the Improvement". *Glocalized Solutions for Sustainability in Manufacturing*: 569-574. doi: [https://doi.org/10.1007/978-3-642-19692-8\\_99](https://doi.org/10.1007/978-3-642-19692-8_99).
- Nasr, E.A., and A.K. Kamrani. 2007. *Computer-based design and manufacturing an information-based approach*. Springer.
- Niazi, A., J.S. Dai, S. Balabani, and L. Seneviratne. 2005. "Product Cost Estimation: Technique Classification and Methodology Review". *Journal of Manufacturing Science and Engineering* 128 (2): 563-575. doi: <https://doi.org/10.1115/1.2137750>.
- Nitesh-Prakash, W., V.G. Sridhar, and K. Annamalai. 2014. "New Product Development by DfMA and Rapid Prototyping". *Journal of Engineering and Applied Sciences* 9 (3): 274-279.

- O'Driscoll, M. 2002. "Design for manufacture". *Journal of Materials Processing Technology* 122 (2-3): 318-321. doi: [https://doi.org/10.1016/S0924-0136\(01\)01132-3](https://doi.org/10.1016/S0924-0136(01)01132-3).
- Pahl, G., W. Beitz, J. Feldhusen, and K.H. Grote. 2007. *Engineering Design: A Systematic Approach*. 3rd ed. Springer.
- Poli, C. 2001. *Design for manufacturing: a structured approach*. Elsevier.
- Sanfilippo, E.M., and S. Borgo. 2016. "What are features? An ontology-based review of the literature" *Computer-Aided Design* 80: 9-18. doi: <http://dx.doi.org/10.1016/j.cad.2016.07.001>.
- Selvaraj, P., P. Radhakrishnan, and M. Adithan. 2009. "An integrated approach to design for manufacturing and assembly based on reduction of product development time and cost". *The International Journal of Advanced Manufacturing Technology* 42: 13-29. doi: <https://doi.org/10.1007/s00170-008-1580-8>.
- Staub-French, S., M. Fischer, J. Kunz, K. Ishii, and B. Paulson. 2003. "A feature ontology to support construction cost estimating". *AI EDAM: Artificial Intelligence for Engineering Design, Analysis and Manufacturing* 17 (2): 133-154. doi: <https://doi.org/10.1017/S0890060403172034>.
- Sunil, V.B., and S.S. Pande. 2008. "Automatic recognition of features from freeform surface CAD models" *Computer-Aided Design* 40 (4): 502-517. doi: <https://doi.org/10.1016/j.cad.2008.01.006>.
- Sunil, V.B., R. Agarwal, and S.S. Pande. "An approach to recognize interacting features from B-Rep CAD models of prismatic machined parts using a hybrid (graph and rule based) technique". *Computers in Industry* 61 (7): 686-701. doi: <https://doi.org/10.1016/j.compind.2010.03.011>.
- Thompson, M.T., I.K.J. Jespersen, and T. Kjærgaard. 2018. "Design for manufacturing and assembly key performance indicators to support high-speed product development". *Procedia CIRP* 70: 114-119. doi: <https://doi.org/10.1016/j.procir.2018.02.005>.
- Ulrich, K.T., and S.D. Eppinger. 2011. *Product Design and Development*, 5th edition. USA. McGraw-Hill Education.
- Vhangade, H.B., B.T. Patil, B.U. Vhangade, and J. Desai. 2017. "Design for Manufacturing Integration Ontologies and Analysis in Computer Aided Designing". *International Journal of Innovative Research in Science, Engineering and Technology* 6 (6): 11173-11779. doi: <https://doi.org/10.15680/IJRSET.2017.0606152>.
- Wang, J., D. Gu, Z. Yu, C. Tan, and L. Zhou. 2012. "A framework for 3D model reconstruction in reverse engineering". *Computers & Industrial Engineering* 63 (4): 1189-1200. doi: <http://dx.doi.org/10.1016/j.cie.2012.07.009>.
- Yang, D., M. Dong, and R. Miao. 2008. "Development of a product configuration system with an ontology-based approach" *Computer-Aided Design* 40 (8): 863-878. doi: <https://doi.org/10.1016/j.cad.2008.05.004>.
- Yim, S., and D.W. Rosen. 2008. "A repository for DFM problems using description logics". *Journal of Manufacturing Technology Management* 19 (6): 755-774. doi: <https://doi.org/10.1108/17410380810888139>.
- Zhang, X., J. Wang, K. Yamazaki, and M. Mori. 2004. "A surface based approach to recognition of geometric features for quality freeform surface machining" *Computer-Aided Design* 36 (8): 735-744. doi: <https://doi.org/10.1016/j.cad.2003.09.002>.

## List of acronyms

<i>2D</i>	<i>Two dimensional</i>
<i>3D</i>	<i>Three dimensional</i>
<i>CAD</i>	<i>Computer Aided Design</i>
<i>CAPP</i>	<i>Computer-aided process planning</i>
<i>CNC</i>	<i>Computerized Numerical Control</i>
<i>DB</i>	<i>Database</i>
<i>DfA</i>	<i>Design for Assembly</i>
<i>DfM</i>	<i>Design for Manufacturing</i>
<i>DfMA</i>	<i>Design for Manufacturing and Assembly</i>
<i>DfX</i>	<i>Design for X</i>
<i>DtC</i>	<i>Design to Cost</i>
<i>EDM</i>	<i>Electrical Discharge Machining</i>
<i>GUI</i>	<i>Graphic User interface</i>
<i>KB</i>	<i>Knowledge Based</i>
<i>KE</i>	<i>Knowledge Engineering</i>
<i>KPIs</i>	<i>Key Performance Indicators</i>
<i>N.A.</i>	<i>Not Applicable</i>
<i>PCB</i>	<i>Printed Circuit Board</i>
<i>PDP</i>	<i>Product Development Process</i>
<i>PMI</i>	<i>Product and Manufacturing Information</i>

## **Appendix A. Component and geometric features of the case study**

[INSERT TABLE 6 HERE]

[INSERT TABLE 7 HERE]

[INSERT TABLE 8 HERE]

[INSERT TABLE 9 HERE]

## **Appendix B. DfM/DfA rules depositories**

[INSERT TABLE 10 HERE]

[INSERT TABLE 11 HERE]

## **Appendix C. Case study cost summary**

[INSERT TABLE 12 HERE]

[INSERT TABLE 13 HERE]

[INSERT TABLE 14 HERE]

[INSERT TABLE 15 HERE]

## Table list

Table 1: overall structure of the repository with two examples of rules

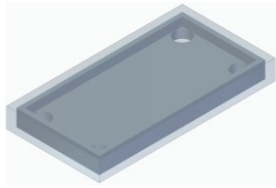
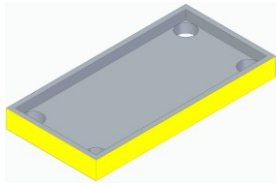
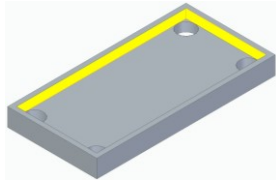
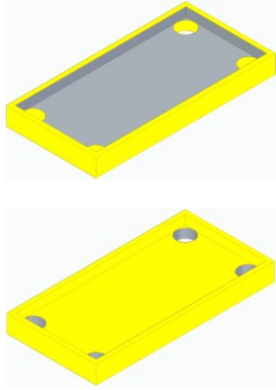
Rule #	Rule type	Manufacturing Technology			Material		CAD features and algorithms		
		Class	Type – Level 1	Type – Level 2	Class	Type	CAD features to recognize	PMI to recognize	Dimensions and rules to verify
1	Warning	Machining	Milling	Drilling	Stainless steel	AISI 304	- Hole D = hole diameter L = hole length	- Roughness Ra = hole roughness	$Ra \leq 0,8 \mu m$ $L/D \geq 5$
2	Warning	Steel metal forming	Stamping and bending	N.A.	Aluminium alloy	N.A.	- Bend - Hole - Slot  r = bend radius t = sheet metal thickness D = distance between bend and hole/slot edge	N.A.	$D \leq r + 4t$

Table 2: design problems and features involved (case study #1)

Component/assembly name	Problems	Features involved
assembly.stp (lid.stp vs. screw.stp)	Guarantee minimum diameter gap between screw and hole of non-threaded parts in the manual assembly process of bolted components	→ Assembly features: → <b>Feature_3</b> – <b>HOLE RECTANGULAR PATTERN (lid)</b> vs. <b>Feature_1</b> – <b>CYLINDRICAL PAD (screw)</b> . <b>Minimum required diameter gap: 1 mm. Actual diameter gap: 0 mm.</b>
lid.stp	Keep limited the ratio between the volume of the raw material and the volume of the finished part in machining processes	→ Component features
	Avoid sharp external edges in machining processes	→ Geometric features: → <b>Feature_1 – PAD</b>
	Avoid sharp internal corners in machining processes	→ Geometric features: → <b>Feature_2 - SLOT</b>
	Avoid holes and slot too close to the edge of the component in machining processes	→ Interaction features: → <b>Feature_3</b> – <b>HOLE RECTANGULAR PATTERN</b> vs <b>Feature_1 – PAD</b> → <b>Feature_2 - SLOT</b> vs <b>Feature_1 - PAD</b>
base.stp	Keep limited the ratio between the volume of the raw material and the volume of the finished part in machining processes	→ Component features
	Avoid sharp external edges in machining processes	→ Geometric features: → <b>Feature_1 – PAD</b>
	Avoid sharp internal corners in machining processes	→ Geometric features: → <b>Feature_2 – SLOT</b>
	Avoid holes and slot too close to the edge of the component in machining processes	→ Interaction features: → <b>Feature_3 – THREADED HOLE RECTANGULAR PATTERN</b> vs <b>Feature_1 – PAD</b> → <b>Feature_2 – SLOT</b> vs <b>Feature_1 - PAD</b>



Table 3: design problems identified for the components and assembly (case study #1)

Analysis: DfM				
Part/Assembly name: Lid				
Knowledge processing			Knowledge representation	
Manufacturing technology	Material	CAD feature recognition	DfM/DfA guideline syntax	DfM/DfA guideline picture
Class: Machining Type - level 1: N.A. Type - level 2: N.A.	Class: All materials Type: N.A.	Recognize: Finished part volume ( $V_f$ ); Raw part volume ( $V_i$ )  PMI: N.A.  Dimensions/geometry: $V_i / V_f > 3$	Action: Keep limited  Subject: The ratio between the volume of the raw material and the volume of the finished part  Context: In machining processes	
Class: Machining Type - level 1: Milling Type - level 2: N.A.	Class: All materials Type: N.A.	Recognize: Edge fillet radius ( $r_{fc}$ )  PMI: N.A.  Dimensions/geometry: $r_{fc} = 0$	Action: Avoid  Subject: Sharp external edges  Context: In machining processes	
Class: Machining Type - level 1: Milling Type - level 2: N.A.	Class: All materials Type: N.A.	Recognize: Corner fillet radius ( $r_{fc}$ )  PMI: N.A.  Dimensions/geometry: $r_{fc} = 0$	Action: Avoid  Subject: Sharp internal corners  Context: In machining processes	
Class: Machining Type - level 1: Milling Type - level 2: Drilling	Class: All materials Type: N.A.	Recognize: Hole, Hole edge, Slot, Slot edge, Surrounding edges, Distance between hole/slot edges and surrounding edges – D  PMI: N.A.  Dimensions/geometry: $D < 3 \text{ mm}$	Action: Avoid  Subject: Holes and slot too close to the edge of the component  Context: In machining processes	
Analysis: DfA				
Part/Assembly name: Assembly				
Knowledge processing			Knowledge representation	
Manufacturing technology	Material	CAD feature recognition	DfM/DfA guideline syntax	DfM/DfA guideline picture

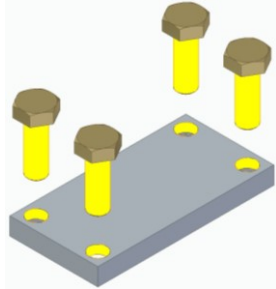
<p>Class: Manual assembly</p> <p>Type - level 1: Bolted</p> <p>Type - level 2: N.A.</p>	<p>Class: All materials</p> <p>Type: N.A.</p>	<p>Recognize: Hole, Hole diameter <math>D_h</math>, Screw, Screw diameter <math>D_s</math>, Diameter gap – <math>G</math></p> <p><math>G = D_h - D_s</math></p> <p><math>G \leq f(D_s)</math> [mm]</p>	<p>Action: Guarantee</p> <p>Subject: Minimum diameter gap between screw and hole of non-threaded parts</p> <p>Context: In the manual assembly process of bolted components</p>	
---	---	--	--	---

Table 4: bill of material (centrifugal pump original design) (case study #2)



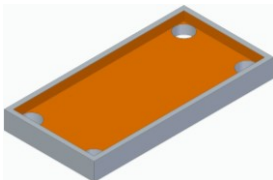
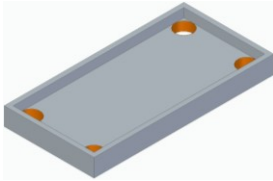
No.	Component	Quantity	Material
1	Cup nut M16	1	39NiCrMo3
2	Casing	1	Grey cast iron
3	Impeller	1	Grey cast iron
4	Wear ring	2	CuAl10Fe5Ni5
5	Coupling	1	AISI 316
6	Packing set	4	Rubber
7	Lantern ring	1	AISI 316
8	Seal chamber	1	AISI 316
9	Packing gland	1	AISI 316
10	Stud ISO 888 M8 x 85	10	39NiCrMo3
11	Plain washer ISO 7089 M8	10	AISI 316
12	Nut DIN ISO 4032 M8	10	39NiCrMo3
13	Hex head screw ISO 4017 M6 x 25	8	39NiCrMo3
14	Taper type grease nipple DIN 71412 A - M6	2	39NiCrMo3
15	Key IS 2048 6 x 6 x 22	1	AISI 316
16	Bearing cover	2	AISI 316
17	Lip seal DIN 3760 A 35 x 50 x 7	2	NDR rubber
18	7207 Radial ball bearing	2	Bearing steel
19	Shaft	1	AISI 316
20	House bearing	1	Grey cast iron
21	Key IS 2048 7 x 8 x 36	1	AISI 316
22	Support	1	AISI 316
23	Nut DIN ISO 4032 M10	1	39NiCrMo3
24	Plain washer ISO 7089 M10	2	AISI 316
25	Hex head screw ISO 4016 M10 x 45	1	39NiCrMo3

Table 5: design problems and features involved (case study #2)

Component/assembly name	Problems	Features involved
<ul style="list-style-type: none"> <li>→ Centrifugal pump.stp (Bearing cover.stp vs. Hex head screw ISO 4017 M6 x 25.stp)</li> <li>→ Centrifugal pump.stp (House bearing.stp vs Hex head screw ISO 4016 M10 x 45.stp)</li> <li>→ Centrifugal pump.stp (House bearing.stp vs. Coupling.stp vs. Stud ISO 888 M8 x 85.stp)</li> <li>→ Centrifugal pump.stp (Packing gland.stp vs. Stud ISO 888 M8 x 85.stp)</li> </ul>	<p>Guarantee minimum diameter gap between screw and hole of non-threaded parts in the manual assembly process of bolted components</p>	<ul style="list-style-type: none"> <li>→ Assembly features:               <ul style="list-style-type: none"> <li>→ Feature_1 – HOLE CIRCULAR PATTERN (Bearing cover) and Feature_1 – CYLINDRICAL PAD (Hex head screw ISO 4017 M6 x 25). Minimum required diameter gap: 0,6 mm. Actual diameter gap: 0 mm.</li> <li>→ Feature_1 – HOLE BASE (House bearing) and Feature_1 – CYLINDRICAL PAD (Hex head screw ISO 4016 M10 x 45). Minimum required diameter gap: 1 mm. Actual diameter gap: 0 mm.</li> <li>→ Feature_2 – HOLE CIRCULAR PATTERN (House bearing), Feature_1 – HOLE CIRCULAR PATTERN (Coupling) and Feature_1 – CYLINDRICAL PAD (Stud ISO 888 M8 x 85). Minimum required diameter gap: 0,8 mm. Actual diameter gap: 0 mm.</li> <li>→ Feature_1 – HOLE LINEAR PATTERN (Packing gland) and Feature_1 – CYLINDRICAL PAD (Stud ISO 888 M8 x 85). Minimum required diameter gap: 0,8 mm. Actual diameter gap: 0 mm.</li> </ul> </li> </ul>
<ul style="list-style-type: none"> <li>→ Centrifugal pump.stp (Bearing cover.stp vs. Hex head screw ISO 4017 M6 x 25.stp)</li> <li>→ Centrifugal pump.stp (House bearing.stp vs Hex head screw ISO 4016 M10 x 45.stp)</li> <li>→ Centrifugal pump.stp (House bearing.stp vs. Coupling.stp vs. Casing.stp vs. Stud ISO 888 M8 x 85.stp)</li> <li>→ Centrifugal pump.stp (Packing gland.stp vs. Coupling.stp vs. Stud ISO 888 M8 x 85.stp)</li> </ul>	<p>Guarantee chamfered/countersunk insertion holes and chamfered screw ends in the manual assembly process of bolted components</p>	<ul style="list-style-type: none"> <li>→ Assembly features:               <ul style="list-style-type: none"> <li>→ Feature_1 – HOLE CIRCULAR PATTERN (Bearing cover), Feature_3 – THREADED HOLE CIRCULAR PATTERN (House bearing) and Feature_1 – CYLINDRICAL PAD (Hex head screw ISO 4017 M6 x 25).</li> <li>→ Feature_1 – HOLE BASE (House bearing) and Feature_1 – CYLINDRICAL PAD (Hex head screw ISO 4016 M10 x 45).</li> <li>→ Feature_2 – HOLE CIRCULAR PATTERN (House bearing), Feature_1 – HOLE CIRCULAR</li> </ul> </li> </ul>

		<p><b>PATTERN (Coupling), Feature_1 – HOLE CIRCULAR PATTERN (Casing) and Feature_1 – CYLINDRICAL PAD (Stud ISO 888 M8 x 85).</b></p> <p>→ <b>Feature_1 – HOLE LINEAR PATTERN (Packing gland), Feature_2 – THREADED HOLE LINEAR PATTERN (Coupling) and Feature_1 – CYLINDRICAL PAD (Stud ISO 888 M8 x 85).</b></p>
<p>→ Centrifugal pump.stp (Stud ISO 888 M8 x 85.stp, plain washer ISO 7089 M8.stp and nut DIN ISO 4032 M8.stp in the connection between casing.stp (2) and coupling.stp (5).)</p> <p>→ Centrifugal pump.stp (Stud ISO 888 M8 x 85.stp, plain washer ISO 7089 M8.stp and nut DIN ISO 4032 M8.stp in the connection between packing gland.stp (9) and coupling.stp (5).)</p> <p>→ Centrifugal pump.stp (Nut DIN ISO 4032 M10.stp, plain washer ISO 7089 M10.stp and hex head screw ISO 4016 M10 x 45.stp in the connection between house bearing.stp (20) and support.stp (22))</p>	<p>Prefer the use of combined fasteners in the manual assembly process of bolted components</p>	<p>→ Assembly features:</p> <p>→ <b>Stud ISO 888 M8 x 85, plain washer ISO 7089 M8 and nut DIN ISO 4032 M8 in the connection between casing (2) and coupling (5).</b></p> <p>→ <b>Stud ISO 888 M8 x 85, plain washer ISO 7089 M8 and nut DIN ISO 4032 M8 in the connection between packing gland (9) and coupling (5).</b></p> <p>→ <b>Nut DIN ISO 4032 M10, plain washer ISO 7089 M10 and hex head screw ISO 4016 M10 x 45 in the connection between house bearing (20) and support (22).</b></p>
<p>Coupling.stp</p>	<p>Reduce the length of the threaded section to values smaller than 2 times the diameter of the hole in the case of both blind and through threaded holes</p>	<p>→ Geometric features:</p> <p>→ <b>Feature_2 – THREADED HOLE LINEAR PATTERN (Coupling) Maximum required threaded length: 16 mm. Actual threaded length: 56 mm.</b></p>

Table 6: component and geometric features of lid component (technology – machining: milling) and assembly (case study #1)

Feature type	Feature image	Feature description
Component features		<ul style="list-style-type: none"> <li>→ Material: Aluminium alloy – 1060</li> <li>→ Volume: 27054,20 [mm<sup>3</sup>]</li> <li>→ Mass: 0,07 [kg] (73,37[gr])</li> <li>→ Area: 14400,00 [mm<sup>2</sup>]</li> </ul>
Geometric features		<ul style="list-style-type: none"> <li>→ Type of feature: <b>Feature_1 – PAD</b></li> <li>→ Coordinates of the feature in reference with origin: [50;-25;00] [50;25;00] [-50;25;00] [-50;-25;00]</li> <li>→ Properties of the feature: <ul style="list-style-type: none"> <li>→ Height: 10 [mm]</li> </ul> </li> <li>→ Volume of the feature: 50000,00 [mm<sup>3</sup>]</li> <li>→ Area of the feature: 13000,00 [mm<sup>2</sup>]</li> <li>→ Faces of the feature: <ul style="list-style-type: none"> <li>→ Rectangular_face_01.01</li> <li>→ Rectangular_face_01.02</li> <li>→ Rectangular_face_01.03</li> <li>→ Rectangular_face_01.04</li> <li>→ Rectangular_face_01.05</li> <li>→ Rectangular_face_01.06</li> </ul> </li> <li>→ PMI: <ul style="list-style-type: none"> <li>→ Specific roughness: <ul style="list-style-type: none"> <li>→ Ra 1,6 [µm] on: <ul style="list-style-type: none"> <li>→ Rectangular_face_01.02</li> </ul> </li> </ul> </li> <li>→ Specific tolerance: NO</li> <li>→ Coating: NO</li> </ul> </li> </ul>
Geometric features		<ul style="list-style-type: none"> <li>→ Type of feature: <b>Feature_2 – SLOT</b></li> <li>→ Coordinates of the feature in reference with origin: [47,5;-22,5;10] [47,5;22,5;10] [-47,5;22,5;00] [-47,5;-22,5;10]</li> <li>→ Properties of the feature: <ul style="list-style-type: none"> <li>→ Depth: 5 [mm]</li> </ul> </li> <li>→ Volume of the feature: 20250,00 [mm<sup>3</sup>]</li> <li>→ Area of the feature: 5400,00 [mm<sup>2</sup>]</li> <li>→ Faces of the feature: <ul style="list-style-type: none"> <li>→ Rectangular_face_02.01</li> <li>→ Rectangular_face_02.02</li> <li>→ Rectangular_face_02.03</li> <li>→ Rectangular_face_02.04</li> <li>→ Rectangular_face_02.05</li> <li>→ Rectangular_face_02.06</li> </ul> </li> <li>→ PMI: <ul style="list-style-type: none"> <li>→ Specific roughness: NO</li> <li>→ Specific tolerance: NO</li> <li>→ Coating: NO</li> </ul> </li> </ul>
Geometric features		<ul style="list-style-type: none"> <li>→ Type of feature: <b>Feature_3 – HOLE RECTANGULAR PATTERN</b></li> <li>→ Coordinates of the feature in reference with origin: <ul style="list-style-type: none"> <li>→ For rectangular pattern [42,5;-17,5;05] [42,5;17,5;05] [-42,5;17,5;05] [-42,5;-17,5;05]</li> </ul> </li> <li>→ Properties of the feature: <ul style="list-style-type: none"> <li>→ For holes: <ul style="list-style-type: none"> <li>→ Diameter: 10 [mm]</li> <li>→ Length: 5 [mm]</li> </ul> </li> </ul> </li> <li>→ Volume of the feature: 1570,80 [mm<sup>3</sup>]</li> <li>→ Area of the feature: 1256,64 [mm<sup>2</sup>]</li> <li>→ Faces of the feature: <ul style="list-style-type: none"> <li>→ Circular_face_03.01</li> <li>→ Circular_face_03.02</li> <li>→ Circular_face_03.03</li> <li>→ Circular_face_03.04</li> <li>→ Circular_face_03.05</li> <li>→ Circular_face_03.06</li> <li>→ Circular_face_03.07</li> <li>→ Circular_face_03.08</li> <li>→ Cilindrical_face_03.01</li> <li>→ Cilindrical_face_03.02</li> <li>→ Cilindrical_face_03.03</li> <li>→ Cilindrical_face_03.04</li> </ul> </li> </ul>

Interaction features

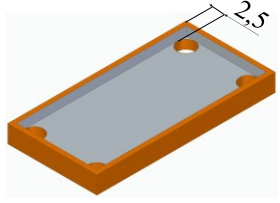
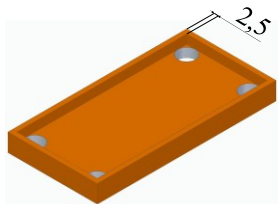
	<ul style="list-style-type: none"><li>→ PMI:</li><li>→ Specific roughness:<ul style="list-style-type: none"><li>→ Ra 1,6 [µm] on:<ul style="list-style-type: none"><li>→ Cilindrical_face_03.01</li><li>→ Cilindrical_face_03.02</li><li>→ Cilindrical_face_03.03</li><li>→ Cilindrical_face_03.04</li></ul></li></ul></li><li>→ Specific tolerance: NO</li><li>→ Coating: NO</li></ul>
	<ul style="list-style-type: none"><li>→ Type of feature vs. type/s of feature/s: <b>Feature_3 – HOLE</b> vs. <b>RECTANGULAR PATTERN vs. Feature_1 – PAD</b></li><li>→ Coordinates of the feature vs. coordinates of the feature/s:<ul style="list-style-type: none"><li>→ [42,5;-17,5;05] vs [50;-25;00]</li></ul></li><li>→ Properties of the feature vs. properties of the feature:<ul style="list-style-type: none"><li>→ Minimum distance: 2,5 [mm]</li></ul></li></ul>
	<ul style="list-style-type: none"><li>→ Type of feature vs. type/s of feature/s: <b>Feature_2 – SLOT vs. Feature_1 – PAD</b></li><li>→ Coordinates of the feature vs. coordinates of the feature/s:<ul style="list-style-type: none"><li>→ [47,5;-22,5;10] vs [50;-25;00]</li></ul></li><li>→ Properties of the feature vs. properties of the feature:<ul style="list-style-type: none"><li>→ Minimum distance: 2,5 [mm]</li></ul></li></ul>

Table 7: component and geometric features of assembly (technology – manual assembly: bolted) (case study #1)

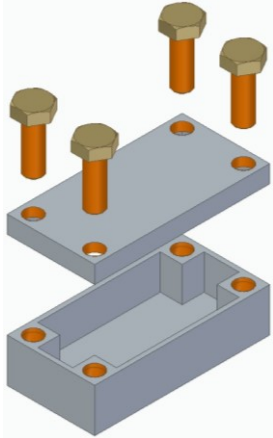
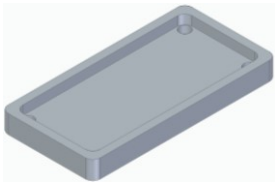
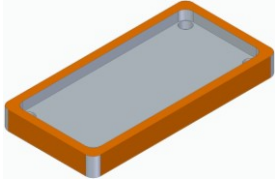
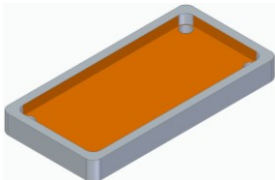
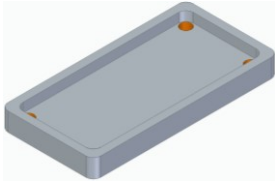
Feature type	Feature image	→ Feature description
Assembly features		<ul style="list-style-type: none"> <li>→ Type of feature vs. type/s of feature/s: <b>Feature_3 – HOLE RECTANGULAR PATTERN (lid) vs. Feature_2 – THREADED HOLE RECTANGULAR PATTERN (base)</b></li> <li>→ Coordinates of the feature vs. coordinates of the feature/s: <ul style="list-style-type: none"> <li>→ [42,5;-17,5;05] [42,5;17,5;05] [-42,5;17,5;05] [-42,5;-17,5;05]</li> <li>vs. [42,5;-17,5;05] [42,5;17,5;05] [-42,5;17,5;05] [-42,5;-17,5;05]</li> </ul> </li> <li>→ Properties of the feature vs. properties of the feature: <ul style="list-style-type: none"> <li>→ Axis gap: 0 [mm]</li> <li>→ Diameter gap: 0 [mm]</li> </ul> </li> <li>→ Type of feature vs. type/s of feature/s: <b>Feature_3 – HOLE RECTANGULAR PATTERN (lid) vs. Feature_1 – CYLINDRICAL PAD (screw)</b></li> <li>→ Coordinates of the feature vs. coordinates of the feature/s: <ul style="list-style-type: none"> <li>→ [42,5;-17,5;05] [42,5;17,5;05] [-42,5;17,5;05] [-42,5;-17,5;05]</li> <li>vs. [42,5;-17,5;05] [42,5;17,5;05] [-42,5;17,5;05] [-42,5;-17,5;05]</li> </ul> </li> <li>→ Properties of the feature vs. properties of the feature: <ul style="list-style-type: none"> <li>→ Axis gap: 0 [mm]</li> <li>→ Diameter gap: 0 [mm]</li> </ul> </li> <li>→ Type of feature vs. type/s of feature/s: <b>Feature_2 – THREADED HOLE RECTANGULAR PATTERN (base) vs. Feature_1 – CYLINDRICAL PAD (screw)</b></li> <li>→ Coordinates of the feature vs. coordinates of the feature/s: <ul style="list-style-type: none"> <li>→ [42,5;-17,5;05] [42,5;17,5;05] [-42,5;17,5;05] [-42,5;-17,5;05]</li> <li>vs. [42,5;-17,5;05] [42,5;17,5;05] [-42,5;17,5;05] [-42,5;-17,5;05]</li> </ul> </li> <li>→ Properties of the feature vs. properties of the feature: <ul style="list-style-type: none"> <li>→ Axis gap: 0 [mm]</li> <li>→ Diameter gap: 0 [mm]</li> </ul> </li> </ul>



Table 8: component and geometric features of modified lid component (technology – machining: milling) and assembly (case study #1)

Feature type	Feature image	Feature description
Component features		<ul style="list-style-type: none"> <li>→ Material: Aluminium alloy – 1060</li> <li>→ Volume: 30046,20 [mm<sup>3</sup>]</li> <li>→ Mass: 0,08 [kg] (81,12[gr])</li> <li>→ Area: 14360,20 [mm<sup>2</sup>]</li> </ul>
Geometric features		<ul style="list-style-type: none"> <li>→ Type of feature: <b>Feature_1 – PAD</b></li> <li>→ Coordinates of the feature in reference with origin: [50;-25;00] [50;25;00] [-50;25;00] [-50;-25;00]</li> <li>→ Properties of the feature: <ul style="list-style-type: none"> <li>→ Height: 10 [mm]</li> </ul> </li> <li>→ Volume of the feature: 50000,00 [mm<sup>3</sup>]</li> <li>→ Area of the feature: 13000,00 [mm<sup>2</sup>]</li> <li>→ Faces of the feature: <ul style="list-style-type: none"> <li>→ Rectangular_face_01.01</li> <li>→ Rectangular_face_01.02</li> <li>→ Rectangular_face_01.03</li> <li>→ Rectangular_face_01.04</li> <li>→ Rectangular_face_01.05</li> <li>→ Rectangular_face_01.06</li> </ul> </li> <li>→ PMI: <ul style="list-style-type: none"> <li>→ Specific roughness: <ul style="list-style-type: none"> <li>→ Ra 1,6 [µm] on: <ul style="list-style-type: none"> <li>→ Rectangular_face_01.02</li> </ul> </li> </ul> </li> <li>→ Specific tolerance: NO</li> <li>→ Coating: NO</li> </ul> </li> </ul>
Geometric features		<ul style="list-style-type: none"> <li>→ Type of feature: <b>Feature_2 – SLOT</b></li> <li>→ Coordinates of the feature in reference with origin: [46;-21;10] [46;21;10] [-46;21;00] [-46;-21;10]</li> <li>→ Properties of the feature: <ul style="list-style-type: none"> <li>→ Depth: 5 [mm]</li> </ul> </li> <li>→ Volume of the feature: 19320,00 [mm<sup>3</sup>]</li> <li>→ Area of the feature: 5204,00 [mm<sup>2</sup>]</li> <li>→ Faces of the feature: <ul style="list-style-type: none"> <li>→ Rectangular_face_02.01</li> <li>→ Rectangular_face_02.02</li> <li>→ Rectangular_face_02.03</li> <li>→ Rectangular_face_02.04</li> <li>→ Rectangular_face_02.05</li> <li>→ Rectangular_face_02.06</li> </ul> </li> <li>→ PMI: <ul style="list-style-type: none"> <li>→ Specific roughness: NO</li> <li>→ Specific tolerance: NO</li> <li>→ Coating: NO</li> </ul> </li> </ul>
Geometric features		<ul style="list-style-type: none"> <li>→ Type of feature: <b>Feature_3 – HOLE RECTANGULAR PATTERN</b></li> <li>→ Coordinates of the feature in reference with origin: <ul style="list-style-type: none"> <li>→ For rectangular pattern [42,5;-17,5;05] [42,5;17,5;05] [-42,5;17,5;05] [-42,5;-17,5;05]</li> </ul> </li> <li>→ Properties of the feature: <ul style="list-style-type: none"> <li>→ For holes: <ul style="list-style-type: none"> <li>→ Diameter: 6 [mm]</li> <li>→ Length: 5 [mm]</li> </ul> </li> </ul> </li> <li>→ Volume of the feature: 1570,80 [mm<sup>3</sup>]</li> <li>→ Area of the feature: 1256,64 [mm<sup>2</sup>]</li> <li>→ Faces of the feature: <ul style="list-style-type: none"> <li>→ Circular_face_03.01</li> <li>→ Circular_face_03.02</li> <li>→ Circular_face_03.03</li> <li>→ Circular_face_03.04</li> <li>→ Circular_face_03.05</li> <li>→ Circular_face_03.06</li> <li>→ Circular_face_03.07</li> <li>→ Circular_face_03.08</li> <li>→ Cilindrical_face_03.01</li> <li>→ Cilindrical_face_03.02</li> <li>→ Cilindrical_face_03.03</li> <li>→ Cilindrical face 03.04</li> </ul> </li> </ul>

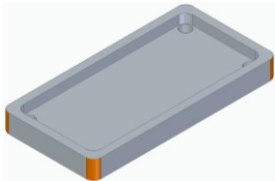
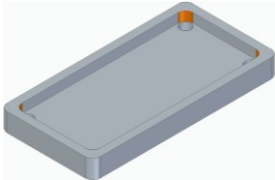
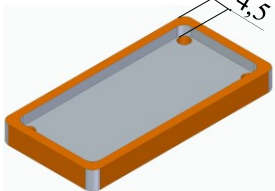
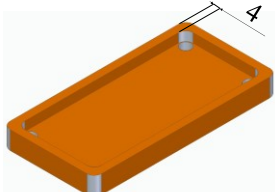
	<ul style="list-style-type: none"> <li>→ PMI: <ul style="list-style-type: none"> <li>→ Specific roughness: <ul style="list-style-type: none"> <li>→ Ra 1,6 [µm] on: <ul style="list-style-type: none"> <li>→ Cilindrical_face_03.01</li> <li>→ Cilindrical_face_03.02</li> <li>→ Cilindrical_face_03.03</li> <li>→ Cilindrical_face_03.04</li> </ul> </li> </ul> </li> <li>→ Specific tolerance: NO</li> <li>→ Coating: NO</li> </ul> </li> </ul>
	<ul style="list-style-type: none"> <li>→ Type of feature: <b>Feature_4 – PAD CORNER FILLETS</b></li> <li>→ Coordinates of the feature in reference with origin: [50;-25;00] [50;25;00] [-50;25;00] [-50;-25;00]</li> <li>→ Properties of the feature: <ul style="list-style-type: none"> <li>→ Radius: 4 [mm]</li> <li>→ Height: 5 [mm]</li> </ul> </li> <li>→ Volume of the feature: 137,34 [mm<sup>3</sup>]</li> <li>→ Area of the feature: 251,25 [mm<sup>2</sup>]</li> <li>→ Faces of the feature: <ul style="list-style-type: none"> <li>→ Semicircular_face_04.01</li> <li>→ Semicircular_face_04.02</li> <li>→ Semicircular_face_04.03</li> <li>→ Semicircular_face_04.04</li> </ul> </li> <li>→ PMI: <ul style="list-style-type: none"> <li>→ Specific roughness: NO</li> <li>→ Specific tolerance: NO</li> </ul> </li> <li>→ Coating: NO</li> </ul>
	<ul style="list-style-type: none"> <li>→ Type of feature: <b>Feature_5 – SLOT CORNER FILLETS</b></li> <li>→ Coordinates of the feature in reference with origin: [46;-21;10] [46;21;10] [-46;21;00] [-46;-21;10]</li> <li>→ Properties of the feature: <ul style="list-style-type: none"> <li>→ Radius: 4 [mm]</li> <li>→ Height: 5 [mm]</li> </ul> </li> <li>→ Volume of the feature: 68,67 [mm<sup>3</sup>]</li> <li>→ Area of the feature: 125,62 [mm<sup>2</sup>]</li> <li>→ Faces of the feature: <ul style="list-style-type: none"> <li>→ Semicircular_face_05.01</li> <li>→ Semicircular_face_05.02</li> <li>→ Semicircular_face_05.03</li> <li>→ Semicircular_face_05.04</li> </ul> </li> <li>→ PMI: <ul style="list-style-type: none"> <li>→ Specific roughness: NO</li> <li>→ Specific tolerance: NO</li> </ul> </li> <li>→ Coating: NO</li> </ul>
<p>Interaction features</p> 	<ul style="list-style-type: none"> <li>→ Type of feature vs. type/s of feature/s: <b>Feature_3 – HOLE RECTANGULAR PATTERN vs. Feature_1 – PAD</b></li> <li>→ Coordinates of the feature vs coordinates of the feature/s: <ul style="list-style-type: none"> <li>→ [42,5;-17,5;05] vs [50;-25;00]</li> </ul> </li> <li>→ Properties of the feature vs properties of the feature: <ul style="list-style-type: none"> <li>→ Minimum distance: 4,5 [mm]</li> </ul> </li> </ul>
	<ul style="list-style-type: none"> <li>→ Type of feature vs. type/s of feature/s: <b>Feature_2 – SLOT vs. Feature_1 – PAD</b></li> <li>→ Coordinates of the feature vs. coordinates of the feature/s: <ul style="list-style-type: none"> <li>→ [46;-21;10] vs [50;-25;00]</li> </ul> </li> <li>→ Properties of the feature vs properties of the feature: <ul style="list-style-type: none"> <li>→ Minimum distance: 4 [mm]</li> </ul> </li> </ul>

Table 9: component and geometric features of modified assembly (technology – manual assembly: bolted) (case study #1)

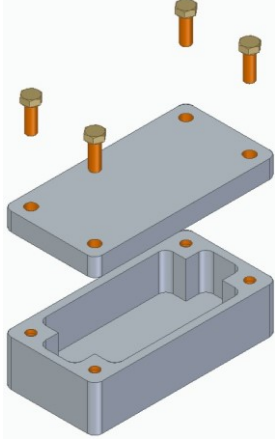
Feature type	Feature image	→ Feature description
Assembly features		<ul style="list-style-type: none"> <li>→ Type of feature vs. type/s of feature/s: <b>Feature_3 – HOLE RECTANGULAR PATTERN (lid) vs. Feature_2 – THREADED HOLE RECTANGULAR PATTERN (base)</b></li> <li>→ Coordinates of the feature vs. coordinates of the feature/s: <ul style="list-style-type: none"> <li>→ [42,5;-17,5;05] [42,5;17,5;05] [-42,5;17,5;05] [-42,5;-17,5;05]</li> <li>vs. [42,5;-17,5;05] [42,5;17,5;05] [-42,5;17,5;05] [-42,5;-17,5;05]</li> </ul> </li> <li>→ Properties of the feature vs. properties of the feature: <ul style="list-style-type: none"> <li>→ Axis gap: 0 [mm]</li> <li>→ Diameter gap: 1 [mm]</li> </ul> </li> <li>→ Type of feature vs. type/s of feature/s: <b>Feature_3 – HOLE RECTANGULAR PATTERN (lid) vs. Feature_1 – CYLINDRICAL PAD (screw)</b></li> <li>→ Coordinates of the feature vs. coordinates of the feature/s: <ul style="list-style-type: none"> <li>→ [42,5;-17,5;05] [42,5;17,5;05] [-42,5;17,5;05] [-42,5;-17,5;05]</li> <li>vs. [42,5;-17,5;05] [42,5;17,5;05] [-42,5;17,5;05] [-42,5;-17,5;05]</li> </ul> </li> <li>→ Properties of the feature vs. properties of the feature: <ul style="list-style-type: none"> <li>→ Axis gap: 0 [mm]</li> <li>→ Diameter gap: 1 [mm]</li> </ul> </li> <li>→ Type of feature vs. type/s of feature/s: <b>Feature_2 – THREADED HOLE RECTANGULAR PATTERN (base) vs. Feature_1 – CYLINDRICAL PAD (screw)</b></li> <li>→ Coordinates of the feature vs. coordinates of the feature/s: <ul style="list-style-type: none"> <li>→ [42,5;-17,5;05] [42,5;17,5;05] [-42,5;17,5;05] [-42,5;-17,5;05]</li> <li>vs. [42,5;-17,5;05] [42,5;17,5;05] [-42,5;17,5;05] [-42,5;-17,5;05]</li> </ul> </li> <li>→ Properties of the feature vs. properties of the feature: <ul style="list-style-type: none"> <li>→ Axis gap: 0 [mm]</li> <li>→ Diameter gap: 0 [mm]</li> </ul> </li> </ul>

Table 10: example of DfM repository for machining – milling technology

Rule #	Rule type	Manufacturing Technology			Material		CAD features and algorithms			Guideline
		Class	Type – Level 1	Type – Level 2	Class	Type	CAD features to recognize	PMI to recognize	Dimensions and rules to verify	
1	Warning	Machining	Milling	N.A.	All materials	N.A.	- Volume Vi = Initial volume Vf = Final volume	N.A.	$S = V_i / V_f$ $S > 3$	Keep limited the ratio between the volume of the raw material and the volume of the finished part in machining processes
2	Warning	Machining	Milling	Drilling	All materials	N.A.	- Hole D = Hole diameter L = Hole length	- Roughness Ra = Hole roughness	Ra – hole roughness $Ra \leq 0,8 \mu m$ $L/D \geq 5$	Avoid tight roughnesses (Ra $\leq 0.8 \mu m$ ) for deep holes (L/D $\geq 5$ ) in machining operations
3	Critical	Machining	Milling	N.A.	All materials	N.A.	- Pocket R = Radius of the pocket edge	N.A.	R = 0	Avoid sharp internal corners in milling operations
4	Warning	Machining	Milling	Drilling	All materials	N.A.	- Hole A = Hole cylinder area R = Hole radius H = Hole height	N.A.	$A \neq 2\pi * R * H$	Avoid partial holes
5	Warning	Machining	Milling	Drilling	All materials	N.A.	- Hole A1 = Hole circular surface A2 = Hole circular surface R = Hole radius	N.A.	$A1 \neq A2 \neq \pi R^2$	Avoid starting hole from the non-flat surface
6	Warning	Machining	Milling	N.A.	All materials	N.A.	- Pocket H = Pocket height W = Pocket width	N.A.	$W \leq 3 \text{ mm}$ $H/W \geq 10$	Avoid pocket widths less than 3mm and with H/W ratio less than 10 in milling operations
7	Warning	Machining	Milling	Drilling	All materials	N.A.	- Hole - Pocket - Slot H = Hole edge P = Pocket edge S = Slot edge E = surrounding edges	N.A.	D = distances among edges $D \leq 3 \text{ mm}$	Avoid holes and slot too close to the edge of the component (less than 3 mm)

8	Warning	Machining	Milling	Threading	All materials	N.A.	- Blind threaded hole H = Hole height Ht = Thread height	N.A.	$Ht \leq 1,25 H$	Guarantee that hole dept is higher than thread dept in blind threaded holes
9	Info	Machining	Milling	Drilling	All materials	N.A.	- Hole D = Hole diameter	N.A.	$D \leq 3 \text{ mm}$	Avoid holes with a diameter less than 3mm
10	Info	Machining	Milling	N.A.	All materials	N.A.	- Pad R = Radius of pad edges	N.A.	$R = 0$	Avoid sharp external corners

Table 11: example of DfA repository for manual assembly – bolted

Rule #	Rule type	Manufacturing Technology			Material		CAD features and algorithms			Guideline
		Class	Type – Level 1	Type – Level 2	Class	Type	CAD features to recognize	PMI to recognize	Dimensions and rules to verify	
1	Critical	Manual assembly	Bolted	N.A.	All materials	N.A.	<ul style="list-style-type: none"> <li>- Threaded elements</li> <li>- Head of the threaded element</li> </ul> <p>A = Threaded axis direction                      P = Plane perpendicular to the threaded axis lean on the head of a threaded element</p>	N.A.	No obstruction along A direction (+ and -) No obstruction on P plane ( $\leq 90^\circ$ )	Guarantee tool entrance for threaded elements (screws, bolts, nuts)
2	Critical	Manual assembly	Bolted	N.A.	All materials	N.A.	<ul style="list-style-type: none"> <li>- Hole</li> <li>- Screw</li> </ul> <p>Ah = Hole axis                      As = Screw axis                      Dh = Hole diameter                      Ds = Screw diameter</p>	N.A.	$G = Dh - Ds$ $Ah = As$ $G \leq f(Ds)$	Guarantee minimum diameter gap between screw and hole in non-threaded parts
3	Critical	Manual assembly	Bolted	N.A.	All materials	N.A.	<ul style="list-style-type: none"> <li>- Hole</li> <li>- Screw</li> <li>- Nut</li> <li>- Threaded hole</li> </ul> <p>Ah = Hole axis                      As = Screw axis                      An = Nut axis                      At = Threaded hole axis</p>	N.A.	$As = An = Ah = At$	Keep aligned screw, nut and hole axis
4	Warning	Manual assembly	Bolted	N.A.	All materials	N.A.	<ul style="list-style-type: none"> <li>- Threaded hole</li> <li>- The chamfer on the threaded hole</li> </ul>	N.A.	Chamfer $< 1 \times 45^\circ$	Prefer threaded holes with chamfer to enable screwing operations
5	Warning	Manual assembly	Bolted	N.A.	All materials	N.A.	<ul style="list-style-type: none"> <li>- Hole</li> <li>- Threaded hole</li> </ul> <p>Ah = Hole area                      At = Threaded hole area</p>	N.A.	$Ah \cap$ other circular areas $At \cap$ other circular areas	Delete non-useful holes and threaded holes in the assembly

Table 12: cost analysis of lid component and assembly (original design) (case study #1)

<b>Analysis: DfM</b>		
<b>Part/Assembly name: Lid</b>		
<b>Cost categories</b>	<b>Geometric features</b>	<b>Cost [€]</b>
<i>Total (Raw material + Operations + Setup + Accessory)</i>	-	10,33
<i>Raw material</i>	-	0,88
<i>Operations</i>	-	8,52
→ Laser cut on:		
→ Rectangular_face_01.03	Feature_1 – PAD	0,34
→ Rectangular_face_01.04		
→ Rectangular_face_01.05		
→ Rectangular_face_01.06		
→ Contouring on:		
→ Rectangular_face_01.03	Feature_1 – PAD and Feature_4 – PAD	0,33
→ Rectangular_face_01.04	CORNER FILLETS	
→ Rectangular_face_01.05		
→ Rectangular_face_01.06		
→ Face milling (rough) on:		
→ Rectangular_face_01.01	Feature_1 – PAD	0,07
→ Rectangular_face_01.02		
→ Single pocket end milling (rough) on:		
→ Rectangular_face_02.01	Feature_2 – SLOT	0,05
→ Rectangular_face_02.02		
→ Rectangular_face_02.03		
→ Rectangular_face_02.04		
→ Face milling (finish) on:		
→ Rectangular_face_01.01	Feature_1 - PAD	0,16
→ Centering on:		
→ Circular_face_03.01	Feature_3 – HOLE RECTANGULAR	0,15
→ Circular_face_03.02	PATTERN	
→ Circular_face_03.03		
→ Circular_face_03.04		
→ Circular_face_03.05		
→ Circular_face_03.06		
→ Circular_face_03.07		
→ Circular_face_03.08		
→ Drilling on:		
→ Circular_face_03.01	Feature_3 – HOLE RECTANGULAR	0,03
→ Circular_face_03.02	PATTERN	
→ Circular_face_03.03		
→ Circular_face_03.04		
→ Circular_face_03.05		
→ Circular_face_03.06		
→ Circular_face_03.07		
→ Circular_face_03.08		
→ Boring on:		
→ Cilindrical_face_03.01	Feature_3 – HOLE RECTANGULAR	0,19
→ Cilindrical_face_03.02	PATTERN	
→ Cilindrical_face_03.03		
→ Cilindrical_face_03.04		
→ EDM on:		
→ Corner between Rectangular_face_02.03 and Rectangular_face_02.04	Feature_2 – SLOT	7,20
→ Corner between Rectangular_face_02.04 and Rectangular_face_02.05		
→ Corner between Rectangular_face_02.05 and Rectangular_face_02.06		
→ Corner between Rectangular_face_02.06 and Rectangular_face_02.03		
<i>Setup</i>	-	0,04

Accessory	-	0,89
-----------	---	------

**Analysis: DfA**

**Part/Assembly name: Assembly**

Cost categories	Assembly features	Cost [€]
<i>Assembly operations</i>	-	<i>N.A.</i>
→ Base.spt positioning	-	0,04
→ Lid.spt positioning and alignment with base.stp	→ Feature_1 – PAD (lid.stp) vs Feature_1 – PAD (base.stp) → Feature_3 – HOLE RECTANGULAR PATTERN (lid.stp) vs Feature_3 – THREADED HOLE RECTANGULAR PATTERN (base.stp)	0,06
→ Screwing M10 screws	→ Feature_3 – HOLE RECTANGULAR PATTERN (lid.stp) vs Feature_1 – CYLINDRICAL PAD (screw) → Feature_3 – THREADED HOLE RECTANGULAR PATTERN (base.stp) vs Feature_1 – CYLINDRICAL PAD (screw)	<i>N.A.</i>



Table 13: cost analysis of lid component and assembly (new design) (case study #1)

<b>Analysis: DfM</b>		
<b>Part/Assembly name: Lid_mod</b>		
<b>Cost categories</b>	<b>Geometric features</b>	<b>Cost [€]</b>
<i>Total (Raw material + Operations + Setup + Accessory)</i>	-	3,79
<i>Raw material</i>	-	0,88
<i>Operations</i>	-	1,91
→ Laser cut on:		
→ Rectangular_face_01.03	Feature_1 – PAD and Feature_4 – PAD	0,33
→ Rectangular_face_01.04	CORNER FILLETS	
→ Rectangular_face_01.05		
→ Rectangular_face_01.06		
→ Contouring on:		
→ Rectangular_face_01.03	Feature_1 – PAD and Feature_4 – PAD	0,33
→ Rectangular_face_01.04	CORNER FILLETS	
→ Rectangular_face_01.05		
→ Rectangular_face_01.06		
→ Face milling (rough) on:		
→ Rectangular_face_01.01	Feature_1 – PAD	0,07
→ Rectangular_face_01.02		
→ Single pocket end milling (rough) on:		
→ Rectangular_face_02.01	Feature_2 – SLOT and Feature_5 – SLOT	0,65
→ Rectangular_face_02.02	CORNER FILLETS	
→ Rectangular_face_02.03		
→ Rectangular_face_02.04		
→ Face milling (finish) on:		
→ Rectangular_face_01.01	Feature_1 – PAD	0,16
→ Centering on:		
→ Circular_face_03.01	Feature_3 – HOLE RECTANGULAR	0,15
→ Circular_face_03.02	PATTERN	
→ Circular_face_03.03		
→ Circular_face_03.04		
→ Circular_face_03.05		
→ Circular_face_03.06		
→ Circular_face_03.07		
→ Circular_face_03.08		
→ Drilling on:		
→ Circular_face_03.01	Feature_3 – HOLE RECTANGULAR	0,03
→ Circular_face_03.02	PATTERN	
→ Circular_face_03.03		
→ Circular_face_03.04		
→ Circular_face_03.05		
→ Circular_face_03.06		
→ Circular_face_03.07		
→ Circular_face_03.08		
→ Boring on:		
→ Cilindrical_face_03.01	Feature_3 – HOLE RECTANGULAR	0,19
→ Cilindrical_face_03.02	PATTERN	
→ Cilindrical_face_03.03		
→ Cilindrical_face_03.04		
<i>Setup</i>	-	0,05
<i>Accessory</i>	-	0,95
<b>Analysis: DfA</b>		
<b>Part/Assembly name: Assembly_mod</b>		
<b>Cost categories</b>	<b>Assembly features</b>	<b>Cost [€]</b>
<i>Assembly operations</i>	-	1,25
Base.spt positioning	-	0,04

Lid.spt positioning and alignment with base.stp	<ul style="list-style-type: none"> <li>→ Feature_1 – PAD (lid.stp) vs Feature_1 – PAD (base.stp)</li> <li>→ Feature_3 – HOLE RECTANGULAR PATTERN (lid.stp) vs Feature_3 – THREADED HOLE RECTANGULAR PATTERN (base.stp)</li> </ul>	0,06
Screwing M10 screws	<ul style="list-style-type: none"> <li>→ Feature_3 – HOLE RECTANGULAR PATTERN (lid.stp) vs Feature_1 – CYLINDRICAL PAD (screw)</li> <li>→ Feature_3 – THREADED HOLE RECTANGULAR PATTERN (base.stp) vs Feature_1 – CYLINDRICAL PAD (screw)</li> </ul>	1,15

Table 14: cost analysis of coupling component and assembly (original design) (case study #2)

<b>Analysis: DfM</b>		
<b>Part/Assembly name: Coupling</b>		
<b>Cost categories</b>	<b>Geometric features</b>	<b>Cost [€]</b>
<i>Total (Raw material + Operations + Setup + Accessory)</i>	-	204,84
<i>Raw material</i>	-	92,73
<i>Operations</i>	-	92,33
→ Raw cutting on:		
→ Circular_face_01.01	Feature_1 – CYLINDER 1	11,34
→ Circular_face_01.02		
→ Cutout on:		
→ Circular_face_02.01	Feature_2 – CUTOUT 1	3,88
→ Cylindrical_face_02.01		
→ Cutout on:		
→ Circular_face_03.01	Feature_3 – SLOT 1	1,27
→ Cylindrical_face_03.01		
→ Cylindrical_face_03.02		
→ Cutout on:		
→ Circular_face_04.01	Feature_4 – CYLINDER 2	1,45
→ Cylindrical_face_04.01		
→ Cutout on:		
→ Cylindrical_face_01.01	Feature_1 – CYLINDER 1	6,80
→ Rectuangular_face_05.01 (x8)	Feature_5 – EXTERNAL CUTOUT	
→ Rectuangular_face_05.02 (x8)		
→ Rectuangular_face_05.03 (x8)		
→ Rectuangular_face_05.04 (x8)		
→ Fillet_05.01 (x8)		
→ Fillet_05.02 (x8)		
→ Fillet_05.03 (x8)		
→ Fillet_05.04 (x8)		
→ Fillet_05.05		
→ Cutout on:		
→ Planar_face_05.01	Feature_5 – EXTERNAL CUTOUT	4,44
→ Fillet_05.06		
→ Circular_face_06.01	Feature_6 – CYLINDER	
→ Cylindrical_face_06.01		
→ Cylindrical_face_07.01	Feature_7 – SLOT 2	
→ Cylindrical_face_07.02		
→ Rectangual_face_07.01 (x2)		
→ Rectangular_face_07.02 (x2)		
→ Triangular_face_07.01 (x2)		
→ Fillet_07.01 (x2)		
→ Fillet_07.02 (x2)		
→ Fillet_07.03		
→ Hole drilling and boring on:		
→ Circular_face_08.01 (x8)	Feature_8 – HOLE CIRCULAR PATTERN	42,56
→ Hole drilling and boring on:		
→ Circular_face_09.01	Feature_9 – HOLE	15,61
→ Hole drilling and treading on:		
→ Circular_face_10.01 (x2)	Feature_10 – TREADED HOLE LINEAR PATTERN	4,98
<i>Setup</i>	-	1,07
<i>Accessory</i>	-	18,71

<b>Analysis: DfA</b>		
<b>Part/Assembly name: Assembly</b>		
<b>Cost categories</b>	<b>Assembly features</b>	<b>Cost [€]</b>
<i>Assembly operations</i>	-	N.A.



Table 15: cost analysis of coupling component and assembly (updated design) (case study #2)

<b>Analysis: DfM</b>		
<b>Part/Assembly name: Coupling</b>		
<b>Cost categories</b>	<b>Geometric features</b>	<b>Cost [€]</b>
<i>Total (Raw material + Operations + Setup + Accessory)</i>	-	196,49
<i>Raw material</i>	-	92,73
<i>Operations</i>	-	91,66
→ Raw cutting on:		
→ Circular_face_01.01	Feature_1 – CYLINDER 1	11,34
→ Circular_face_01.02		
→ Cutout on:		
→ Circular_face_02.01	Feature_2 – CUTOUT 1	3,88
→ Cylindrical_face_02.01		
→ Cutout on:		
→ Circular_face_03.01	Feature_3 – SLOT 1	1,27
→ Cylindrical_face_03.01		
→ Cylindrical_face_03.02		
→ Cutout on:		
→ Circular_face_04.01	Feature_4 – CYLINDER 2	1,45
→ Cylindrical_face_04.01		
→ Cutout on:		
→ Cylindrical_face_01.01	Feature_1 – CYLINDER 1	8,61
→ Rectuangular_face_05.01 (x8)	Feature_5 – EXTERNAL CUTOUT	
→ Rectuangular_face_05.02 (x8)		
→ Rectuangular_face_05.03 (x8)		
→ Rectuangular_face_05.04 (x8)	Feature_6 – CYLINDER	
→ Fillet_05.01 (x8)		
→ Fillet_05.02 (x8)		
→ Fillet_05.03 (x8)		
→ Fillet_05.04 (x8)		
→ Fillet_05.05		
→ Fillet_05.06		
→ Planar_face_05.01		
→ Circular_face_06.01		
→ Cylindrical_face_06.01		
→ Cutout on:		
→ Cylindrical_face_07.01	Feature_7 – SLOT 2	4,44
→ Cylindrical_face_07.02		
→ Rectangular_face_07.01 (x2)		
→ Rectangular_face_07.02 (x2)		
→ Triangular_face_07.01 (x2)		
→ Fillet_07.01 (x2)		
→ Fillet_07.02 (x2)		
→ Fillet_07.03		
→ Chamfering on:		
→ Cylindrical_face_04.01	Feature_4 – CYLINDER 2	0,62
→ Circular_face_04.01		
→ Hole drilling and boring on:		
→ Circular_face_08.01 (x8)	Feature_8 – HOLE CIRCULAR PATTERN	42,56
→ Hole drilling and boring on:		
→ Circular_face_09.01	Feature_9 – HOLE	15,61
→ Hole drilling and treading on:		
→ Circular_face_10.01 (x2)	Feature_10 – HOLE LINEAR PATTERN	1,88
<i>Setup</i>	-	0,98
<i>Accessory</i>	-	11,12
<b>Analysis: DfA</b>		
<b>Part/Assembly name: Assembly</b>		
<b>Cost categories</b>	<b>Assembly features</b>	<b>Cost [€]</b>

Assembly operations	-	15,00
→ 7207 Radial ball bearing positioning, alignment and mounting with Shaft and House bearing (x2)	→ Feature_1 – CYLINDER (shaft.stp) vs Feature_1 – HOLE (House bearing.stp)	1,47
→ Lip seal DIN 3760 A 35 x 50 x 7 positioning, alignment and mounting with Shaft (x2)	→ Feature_1 – CYLINDER (shaft.stp) vs Feature_1 – HOLE (Lip seal DIN 3760 A 35 x 50 x 7.stp)	0,10
→ Bearing cover positioning, alignment and mounting with House bearing and Shaft (x2)	→ Feature_1 – CYLINDER (shaft.stp) vs Feature_1 – HOLE (Bearing cover.stp)	0,10
	→ Feature_1 – PAD (House bearing.stp) vs Feature_2 – PAD (Bearing cover.stp)	
	→ Feature_3 – HOLE RECTANGULAR PATTERN (Bearing cover.stp) vs Feature_1 – CYLINDRICAL PAD (Hex head screw ISO 4017 M6 x 25)	4,40
→ Hex head screw ISO 4017 M6 x 25 positioning, alignment and screwing with Bearing cover and House bearing (x8)	→ Feature_3 – THREADED HOLE RECTANGULAR PATTERN (House bearing.stp) vs Feature_1 – CYLINDRICAL PAD (Hex head screw ISO 4017 M6 x 25)	
	→ Feature_4 – THREADED HOLE (House bearing.stp) vs Feature_1 – CYLINDRICAL PAD (Taper type grease nipple DIN 71412 A - M6)	1,10
→ Taper type grease nipple DIN 71412 A - M6 positioning, alignment and screwing with Bearing cover (x2)	→ Feature_1 – CYLINDER (Seal chamber.stp) vs Feature_1 – HOLE (Packing set.stp)	0,20
→ Packing set positioning, alignment and mounting with Seal chamber (x4)	→ Feature_2 – HOLE (Seal chamber.stp) vs Feature_1 – CYLINDER (Shaft.stp)	0,05
→ Seal chamber positioning, alignment and mounting with Shaft	→ Feature_1 – CYLINDER (Seal chamber.stp) vs Feature_1 – HOLE (Lantern ring.stp)	0,05
→ Lantern ring positioning, alignment and mounting with Seal chamber	→ Feature_1 – HOLE (Packing gland.stp) vs Feature_1 – CYLINDER (Shaft.stp)	0,05
→ Packing gland positioning, alignment and mounting with Shaft	→ Feature_1 – HOLE (Wear ring.stp) vs Feature_1 – CYLINDER (Impeller.stp)	0,05
→ Wear ring positioning, alignment and mounting with Impeller	→ Feature_1 – CYLINDER (Shaft.stp) vs Feature_9 – HOLE (Coupling.stp)	0,05
→ Coupling positioning and alignment with House bearing and Shaft	→ Feature_2 – PAD (House bearing.stp) vs Feature_5 – EXTERNAL CUTOOUT (Coupling.stp)	
	→ Feature_2 – SLOT (Shaft.stp) vs Feature_1 – PAD (Key IS 2048 6 x 6 x 22.stp)	0,05
→ Key IS 2048 6 x 6 x 22 positioning, alignment and mounting with Shaft	→ Feature_1 – CYLINDER (Shaft.stp) vs Feature_1 – HOLE (Impeller.stp)	0,38
→ Impeller positioning, alignment and mounting with Shaft and Coupling	→ Feature_2 – PAD (Impeller.stp) vs Feature_3 – SLOT 1 (Coupling.stp)	
	→ Feature_1 – CYLINDER (Shaft.stp) vs Feature_1 – HOLE (Casing.stp)	0,25
→ Casing positioning, alignment and mounting with Shaft and Coupling	→ Feature_2 – PAD (Casing.stp) vs Feature_3 – SLOT 1 (Coupling.stp)	
	→ Feature_3 – HOLE CIRCULAR PATTERN (House bearing.stp) vs Feature_1 – CYLINDRICAL PAD (Hex head screw DIN 6921 M8 x 65.stp)	4,40
→ Hex head screw DIN 6921 M8 x 65 positioning, alignment and screwing with House bearing, Coupling and Casing (x8)	→ Feature_8 – HOLE CIRCULAR PATTERN (Coupling.stp) vs Feature_1 – CYLINDRICAL PAD (Hex head screw DIN 6921 M8 x 65.stp)	
	→ Feature_3 – THREADED HOLE RECTANGULAR PATTERN (Casing.stp) vs Feature_1 – CYLINDRICAL PAD (Hex head screw DIN 6921 M8 x 65.stp)	
	→ Feature_2 – THREADED CYLINDER (Shaft.stp) vs Feature_1 – THREADED HOLE (Cup nut M16.stp)	0,55
→ Cup nut M16 positioning, alignment and screwing with Shaft and Impeller	→ Feature_2 – PAD (Impeller.stp) vs Feature_2 – PAD (Cup nut M16.stp)	
	→ Feature_2 – HOLE LINEAR PATTERN (Packing gland.stp) vs Feature_1 – CYLINDRICAL PAD (Hex head screw DIN 6921 M8 x 60.stp)	1,10
→ Hex head screw DIN 6921 M8 x 60 positioning, alignment and screwing with Packing gland and Coupling (x2)		

→ Hex head screw DIN 6921 M10 x 40 positioning, alignment and mounting with Support and House bearing	→ Feature_10 – THREADED HOLE LINEAR PATTERN (Coupling.stp) vs Feature_1 – CYLINDRICAL PAD (Hex head screw DIN 6921 M8 x 60.stp) → Feature_5 – HOLE (House bearing.stp) vs Feature_1 – CYLINDRICAL PAD (Hex head screw DIN 6921 M10 x 40.stp)	0,05
→ Nut DIN ISO 4161 M10 positioning, alignment and screwing with Hex head screw DIN 6921 M10 x 40	→ Feature_1 – SLOT (Support.stp) vs Feature_1 – CYLINDRICAL PAD (Hex head screw DIN 6921 M10 x 40.stp) → Feature_1 – THREADED HOLE (Nut DIN ISO 4161 M10.stp) vs Feature_1 – CYLINDRICAL PAD (Hex head screw DIN 6921 M10 x 40.stp)	0,55
→ Key IS 2048 7 x 8 x 36 positioning, alignment and mounting with Shaft	→ Feature_3 – SLOT (Shaft.stp) vs Feature_1 – PAD (Key IS 2048 7 x 8 x 36.stp)	0,05

## Figures list

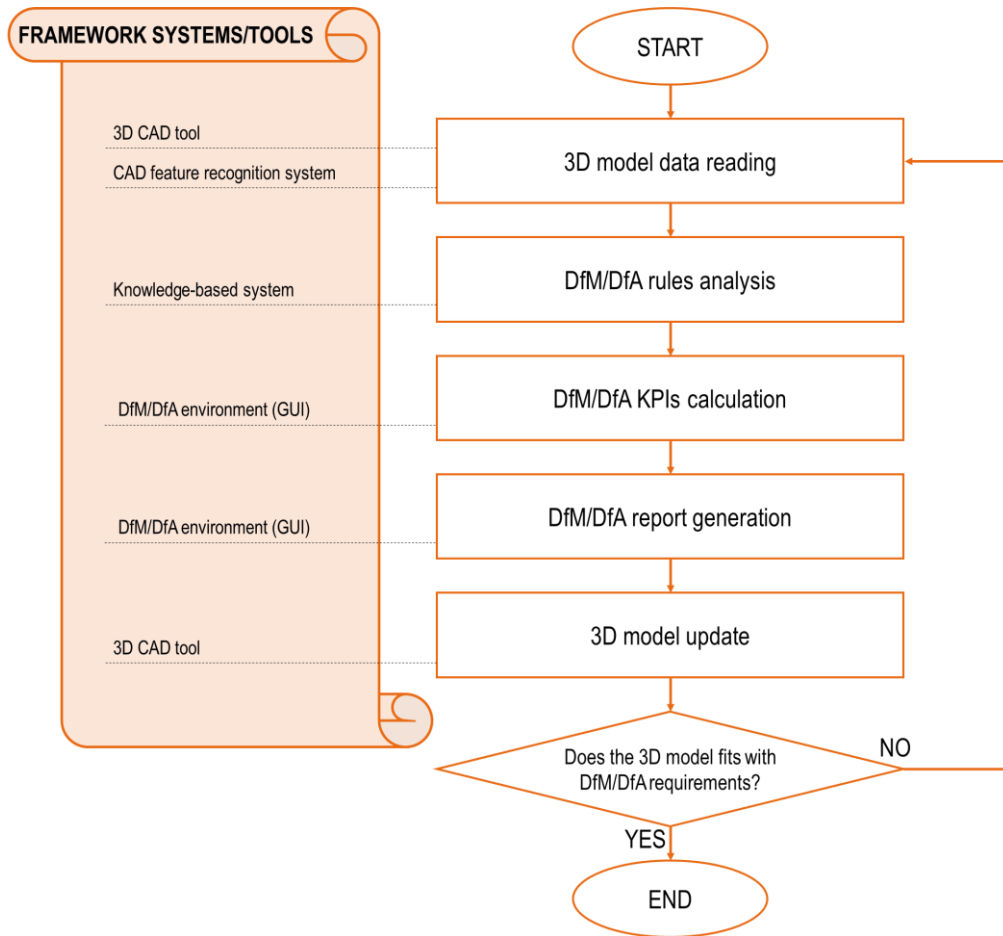


Figure 1: process workflow of CAD-integrated design for manufacturing and assembly



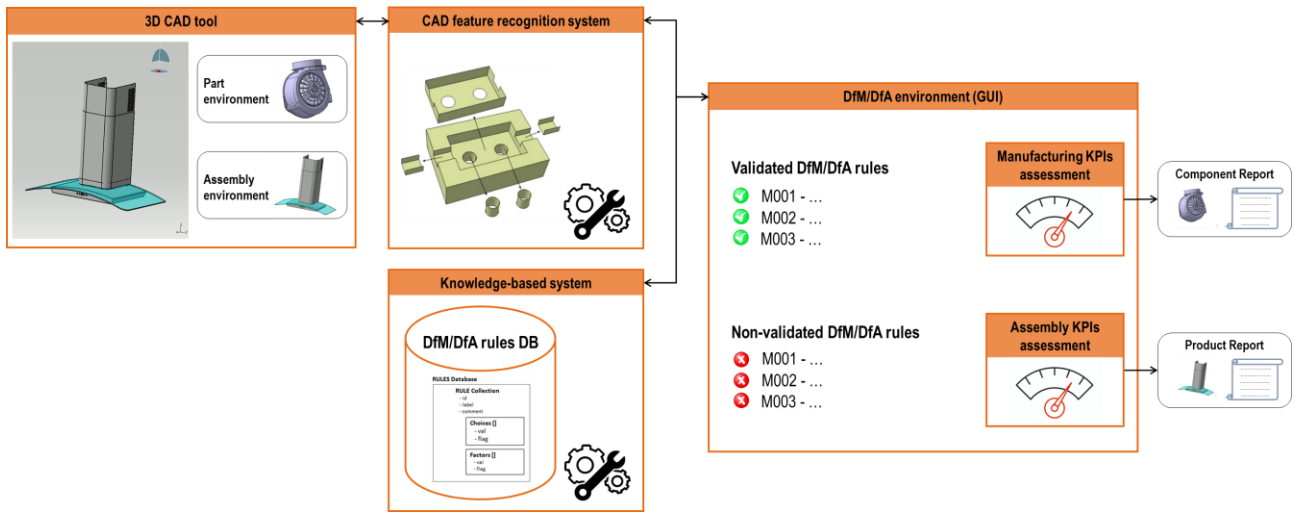
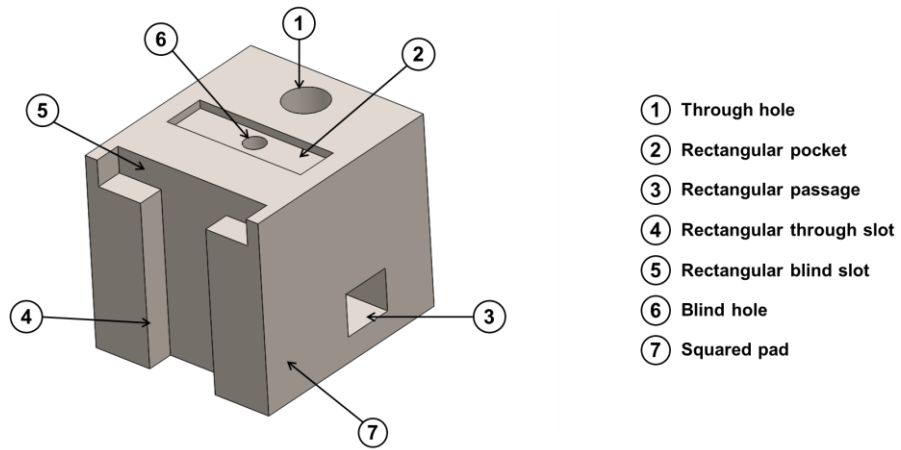


Figure 2: methodological framework of CAD-integrated design for manufacturing and assembly



*Figure 3: example of 3D CAD feature recognition types [Zhang et al., 2018].*

→ DfM/DfA guideline syntax

Action (verb)	Subject (name)	Context (manufacturing process)	Context (type of feature)	Context (type of part)	Context (type of material)
NECESSARY	NECESSARY	OPTIONAL	OPTIONAL	OPTIONAL	OPTIONAL
Avoid	sharp corners	with milling process			
Use	specific roughness		for cylindrical features	in shaft part (bearing assembly)	

→ DfM/DfA guideline picture

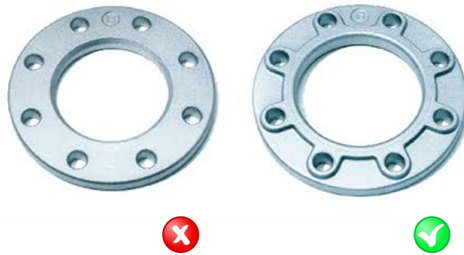


Figure 4: example of DfM/DfA guideline syntax and picture.

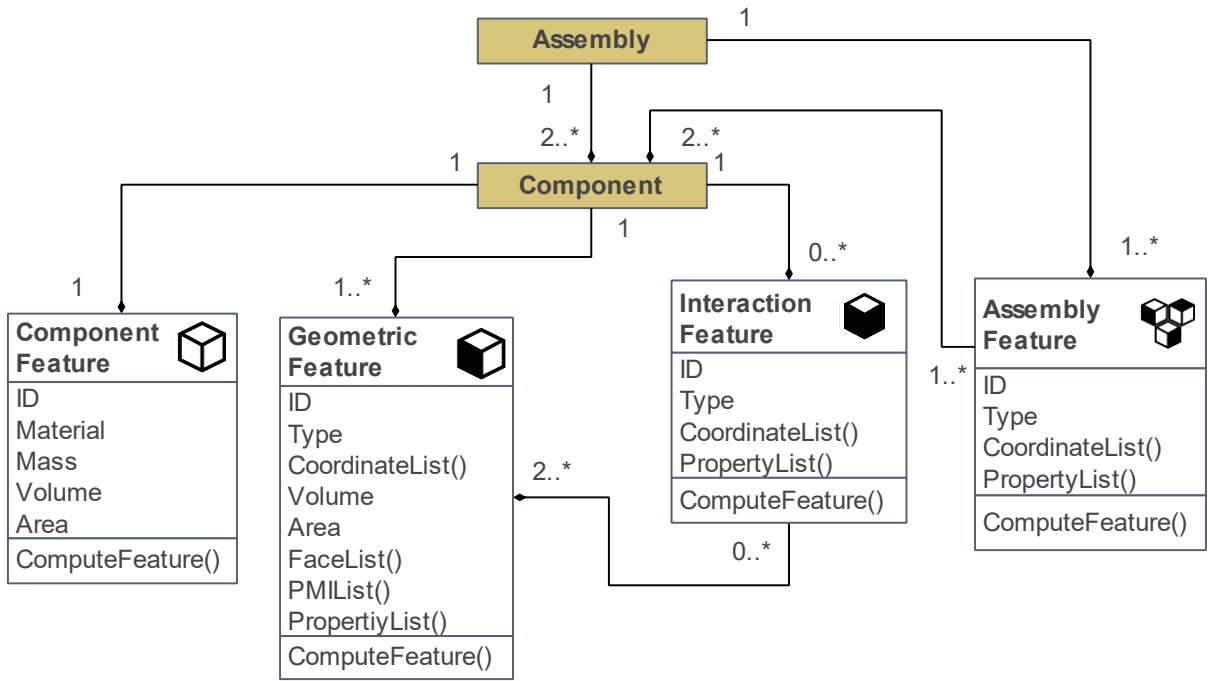
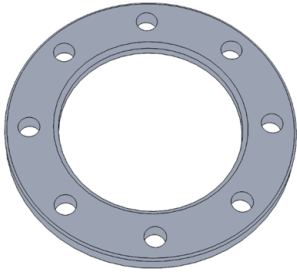
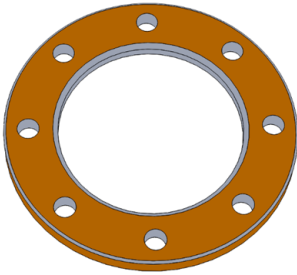


Figure 5: Feature recognition framework (Class Diagram).

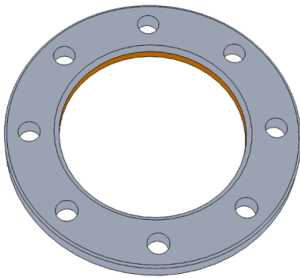


- Material: Aluminium alloy - 1060
- Volume: 49062.28 [mm<sup>3</sup>]
- Mass: 132.47 [gr]
- Area: 18552.95 [mm<sup>2</sup>]

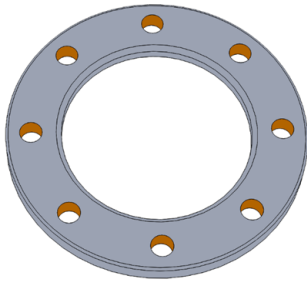
*Figure 6: example of a component feature recognized for a flange 3D model.*



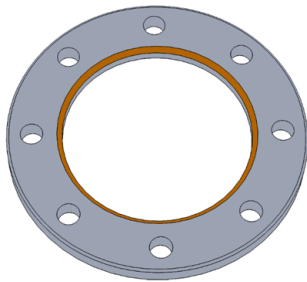
- Type of feature: **Feature\_1 - PAD**
- Coordinates of the feature in reference with origin: [00; 00; 00]
- Properties of the feature:
  - Diameter: 120 [mm]
  - Length: 8 [mm]
- Volume of the feature: 90477.87 [mm<sup>3</sup>]
- Area of the feature: 25635.40 [mm<sup>2</sup>]
- Faces of the feature:
  - Circular\_face\_01.01
  - Circular\_face\_01.02
  - Cylindrical\_face\_01.01
- PMI
  - Specific roughness: Ra 1.6 [μm] on Circular\_face\_01.01
  - Specific tolerance: NO
  - Coating: NO



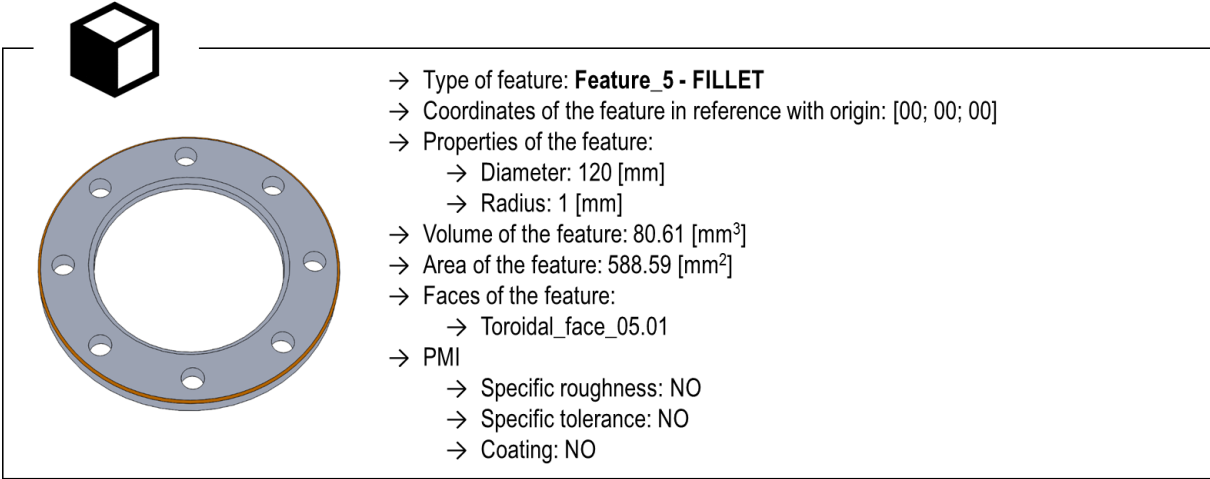
- Type of feature: **Feature\_2 - HOLE**
- Coordinates of the feature in reference with origin: [00; 00; 00]
- Properties of the feature:
  - Diameter: 76 [mm]
  - Length: 8 [mm]
- Volume of the feature: 36273.28 [mm<sup>3</sup>]
- Area of the feature: 6444.25 [mm<sup>2</sup>]
- Faces of the feature:
  - Circular\_face\_02.01
  - Circular\_face\_02.02
  - Cylindrical\_face\_02.01
- PMI
  - Specific roughness: NO
  - Specific tolerance: NO
  - Coating: NO



- Type of feature: **Feature\_3 - HOLE CIRCULAR PATTERN**
- Coordinates of the feature in reference with origin:
  - For circular pattern [00; 0; 00]
  - For first hole [00; 35,3; 35,3]
- Properties of the feature:
  - For circular pattern
    - Diameter: 100 [mm]
  - For holes
    - Diameter: 9 [mm]
    - Length: 8 [mm]
- Volume of the feature: 4069.44 [mm<sup>3</sup>]
- Area of the feature: 2826.88 [mm<sup>2</sup>]
- Faces of the feature:
  - Circular\_face\_03.01 → Circular\_face\_03.09 → Cylindrical\_face\_03.01
  - Circular\_face\_03.02 → Circular\_face\_03.10 → Cylindrical\_face\_03.02
  - Circular\_face\_03.03 → Circular\_face\_03.11 → Cylindrical\_face\_03.03
  - Circular\_face\_03.04 → Circular\_face\_03.12 → Cylindrical\_face\_03.04
  - Circular\_face\_03.05 → Circular\_face\_03.13 → Cylindrical\_face\_03.05
  - Circular\_face\_03.06 → Circular\_face\_03.14 → Cylindrical\_face\_03.06
  - Circular\_face\_03.07 → Circular\_face\_03.15 → Cylindrical\_face\_03.07
  - Circular\_face\_03.08 → Circular\_face\_03.16 → Cylindrical\_face\_03.08
- PMI
  - Specific roughness: Ra 1.6 [μm] on
    - Cylindrical\_face\_03.01
    - Cylindrical\_face\_03.02
    - Cylindrical\_face\_03.03
    - Cylindrical\_face\_03.04
    - Cylindrical\_face\_03.05
    - Cylindrical\_face\_03.06
    - Cylindrical\_face\_03.07
    - Cylindrical\_face\_03.08
  - Specific tolerance: NO
  - Coating: NO



- Type of feature: **Feature\_4 - CHAMFER**
- Coordinates of the feature in reference with origin: [00; 00; 00]
- Properties of the feature:
  - Diameter: 76 [mm]
  - Angle: 45°
  - Size: 2 [mm]
- Volume of the feature: 971.80 [mm<sup>3</sup>]
- Area of the feature: 693.09 [mm<sup>2</sup>]
- Faces of the feature:
  - Conical\_face\_04.01
- PMI
  - Specific roughness: NO
  - Specific tolerance: NO
  - Coating: NO



*Figure 7: examples of geometric features recognized for a flange 3D model*



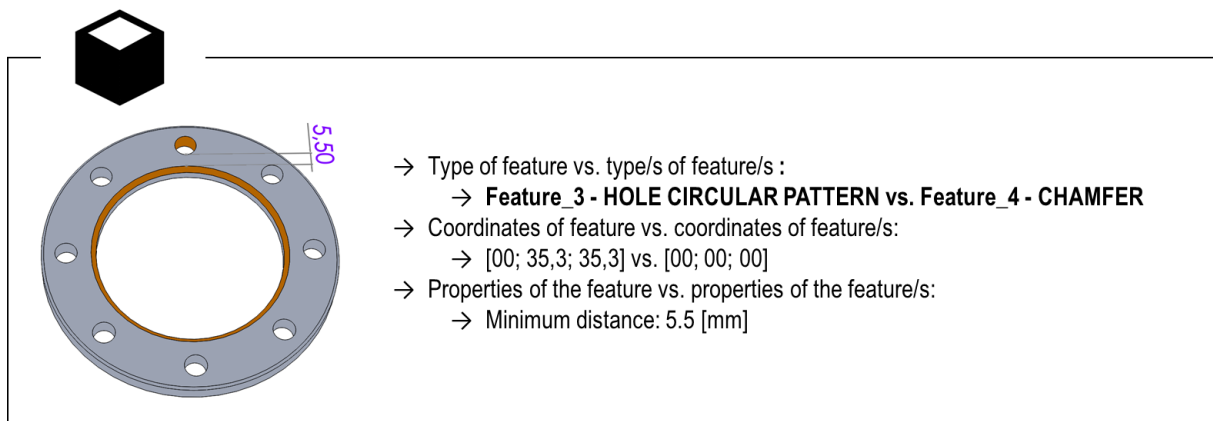
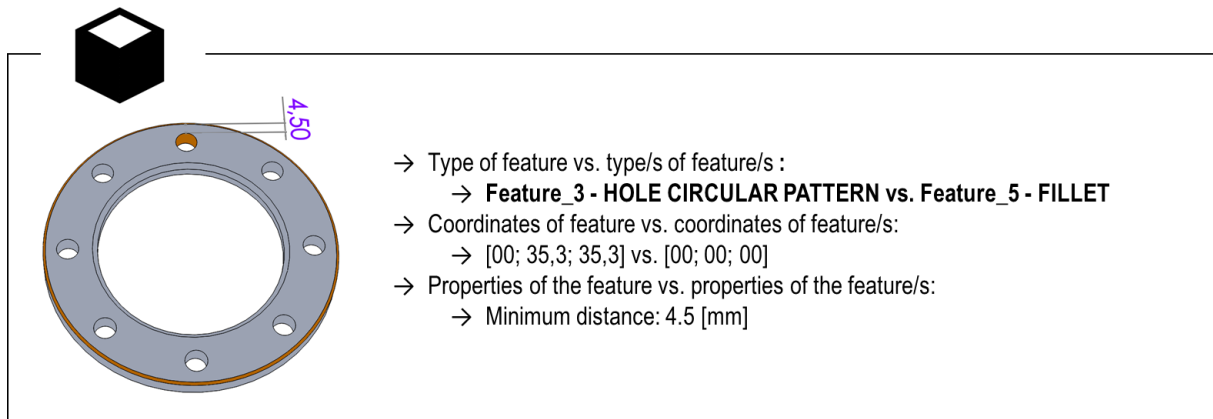
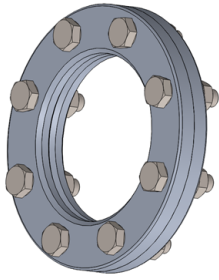
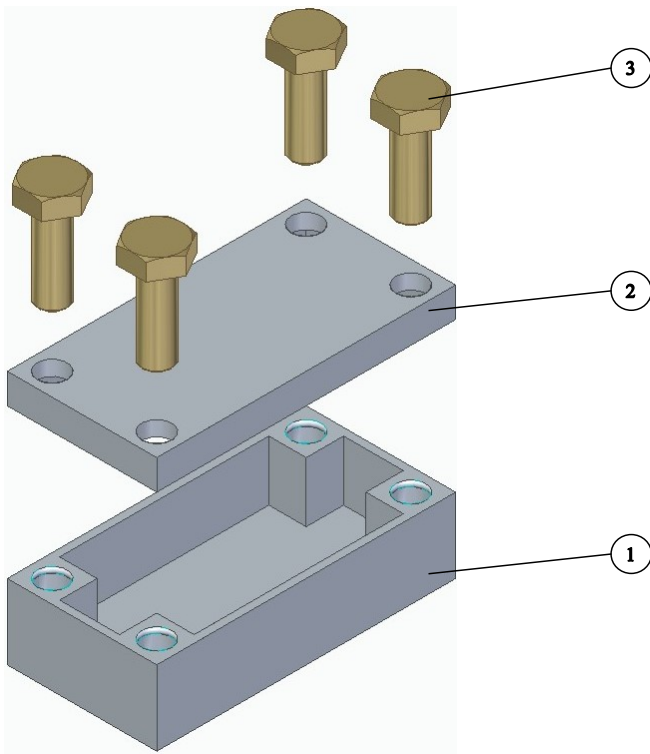


Figure 8: example of interaction features recognized for a flange 3D model.



- Type of feature vs. type/s of feature/s :
  - **Feature\_3 - HOLE CIRCULAR PATTERN (flange\_1) vs.**
  - **Feature\_1 - CYLINDRICAL PAD (hexagonal bolt\_1)**
- Coordinates of feature vs. coordinates of feature/s:
  - [00; 35,3; 35,3] vs. [00; 35,3; 35,3]
- Properties of the feature vs. properties of the feature/s:
  - Axis gap: 0 [mm]
  - Diameter gap: +2 [mm]

*Figure 9: example of assembly features among parts recognized for a 3D assembly model.*



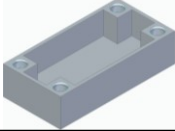


<b>Bill of Materials Case Study (Original design)</b>			
Image	No.	Name	Quantity
	1	Base	1
	2	Lid	1
	3	Screw	4

Figure 10: exploded view and BoM of the case study (original design) (case study #1)

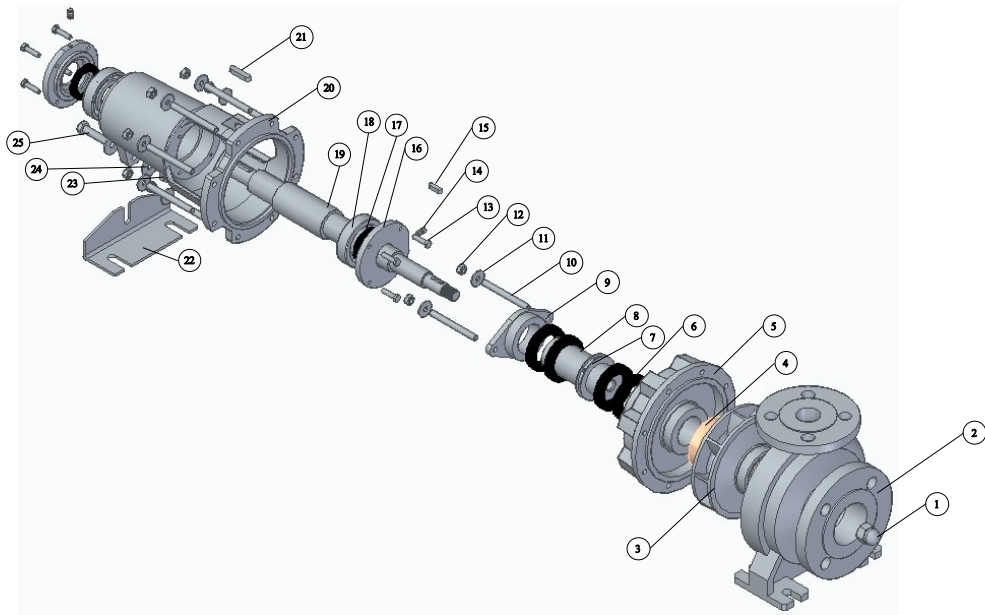
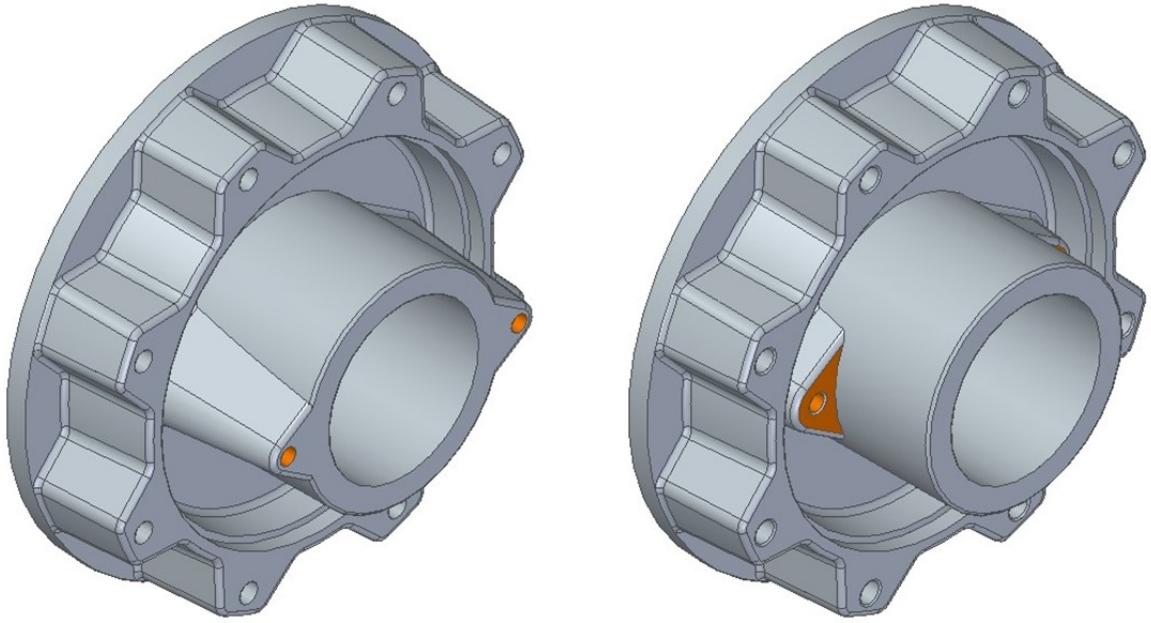


Figure 11: exploded view (centrifugal pump original design) (case study #2)



*Figure 12: original design (left) and updated design (right) of coupling part (case study #2)*

## Figure list captions

Figure 1: process workflow of CAD-integrated design for manufacturing and assembly

Figure 2: methodological framework of CAD-integrated design for manufacturing and assembly

Figure 3: example of 3D CAD feature recognition types [Zhang et al., 2018].

Figure 4: example of DfM/DfA guideline syntax and picture.

Figure 5: Feature recognition framework (Class Diagram).

Figure 6: example of a component feature recognized for a flange 3D model.

Figure 7: examples of geometric features recognized for a flange 3D model

Figure 8: example of interaction features recognized for a flange 3D model.

Figure 9: example of assembly features among parts recognized for a 3D assembly model.

Figure 10: exploded view and BoM of the case study (original design) (case study #1)

Figure 11: exploded view (centrifugal pump original design) (case study #2)

Figure 12: original design (left) and updated design (right) of coupling part (case study #2)